

# SG 4740

---

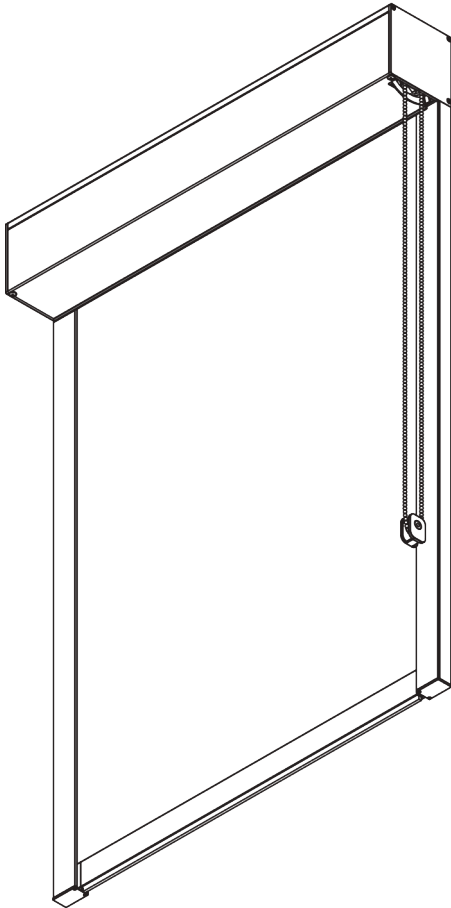
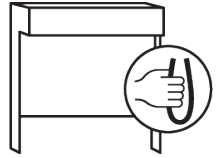

## PRODUKTINFORMATIONEN

- **Bedienung:** Kette
- **Grösse:** L
- **Montage:** Decke, Wand, Nische
- **Farben:** weiss RAL 9016 oder schwarz RAL 9005, Sonderfarben möglich
- **Stoffe:** siehe Silent Gliss Stoffkollektion

### **Merkmale:**

- Zip Technologie
- Rostfreie Stahlkugelskette
- 2:1 Kettenantrieb
- 40 mm Seitenprofile, vorgebohrte Träger Positionierungen

# SYSTEMSPEZIFIKATIONEN

## A. MASSE / GEWICHT



3 m



65 cm

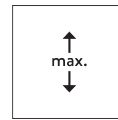

3 m



9 m<sup>2</sup>



6 kg

## B. PROFIL

### Profilinformationen

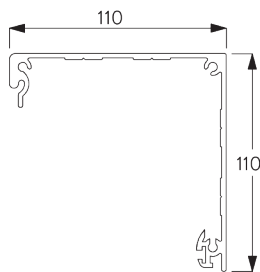

**SG 10998**

Kassettengehäuse 110 mm

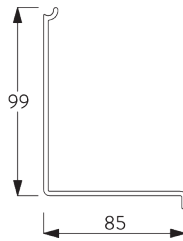

**SG 10999**

Kassettendeckel 110 mm

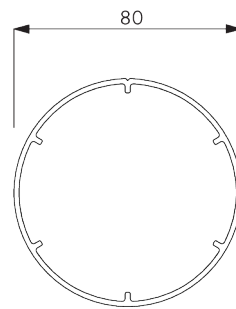

**SG 11003**

Rohr 80 mm

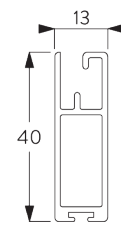

**SG 10993**

Beschwerung

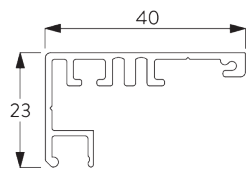

**SG 11418**

Seitliche Führungsschiene



**SG 11419**

Seitliche Abdeckung

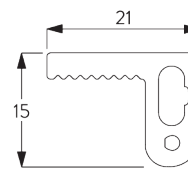

**SG 11421**

Zip-Profil

## C. MASSAUFNAHME

### Untermontage

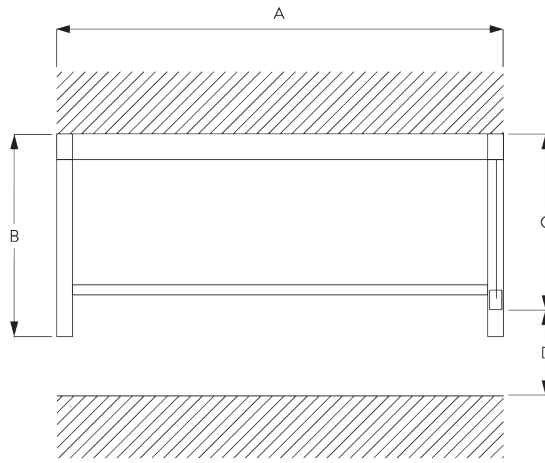

- A: Systembreite
- B: Systemhöhe
- C: Kettenhöhe
- D: Kindersicherung SG 10731 min. 150 cm über Boden

### Aufmontage

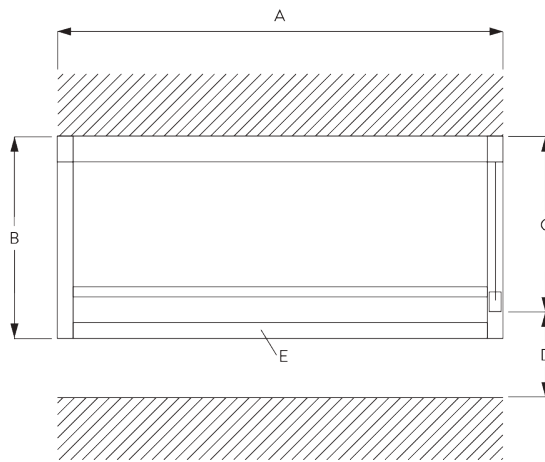

- A: Systembreite
- B: Systemhöhe
- C: Kettenhöhe
- D: Kindersicherung SG 10731 min. 150 cm über Boden
- E: Optional: Abschlussprofil (SG 11418 / SG 11419)

# MONTAGE

## A. MONTAGE- INFORMATIONEN

Detaillierte Montageinformationen siehe  
Silent Gliss Website

### Montagepunkte - Decken-/ Untermontage

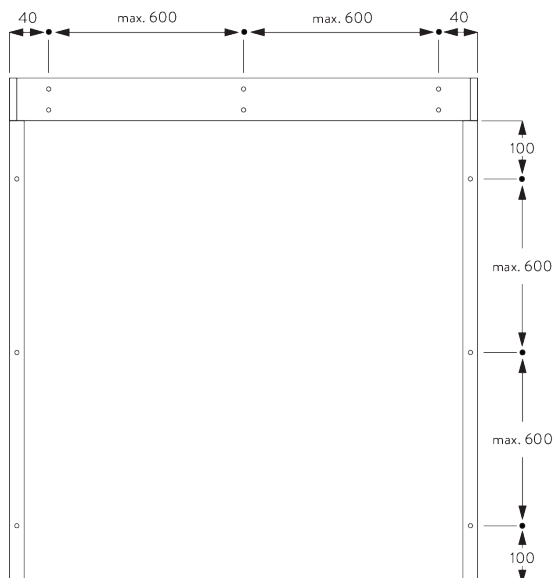

**Montagepunkte -  
Wand-/Aufmontage**

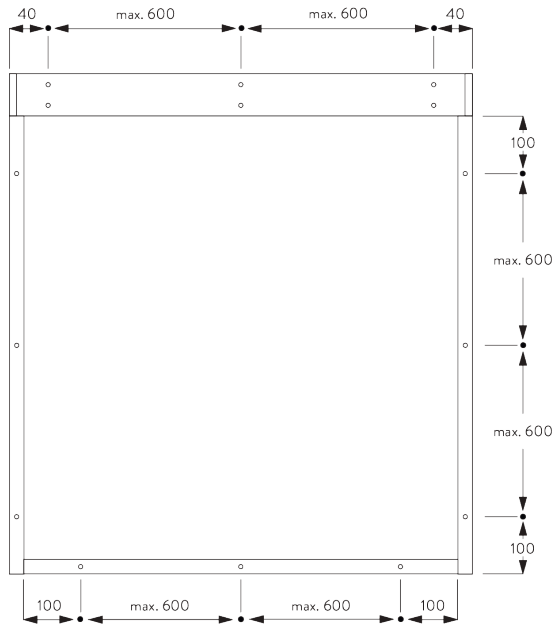

**B. DECKEN-/  
UNTERMONTAGE**

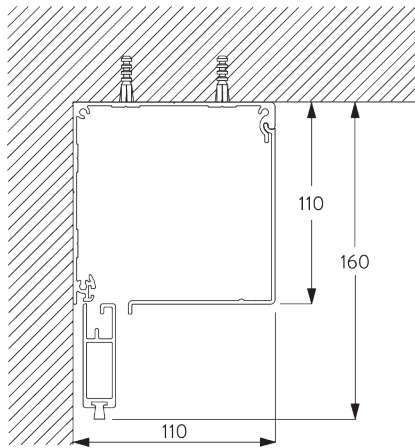

**C. WAND-/  
AUFMONTAGE**

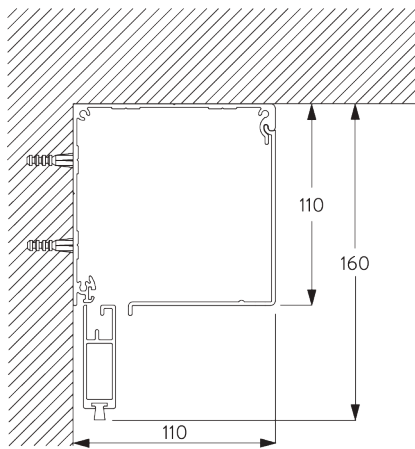

**D. NISCHEN-  
MONTAGE**

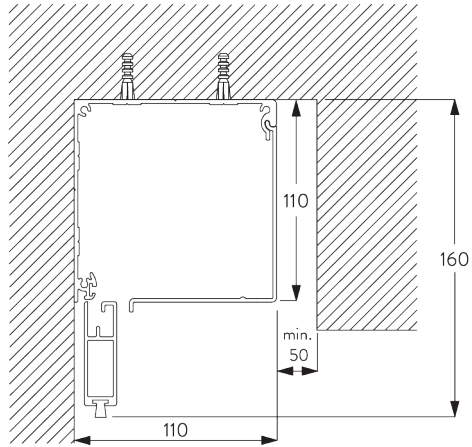

**E. SEITENPROFILE  
SG 11418 / SG 11419**

**Untermontage**

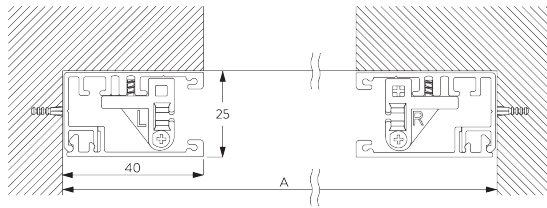

A: Systembreite



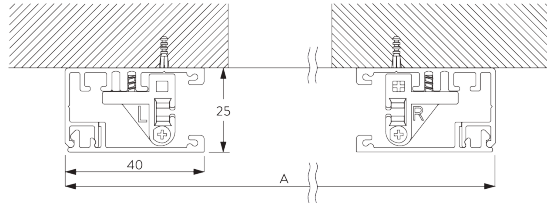







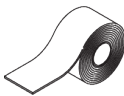

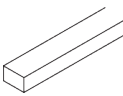
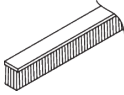
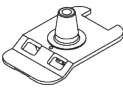
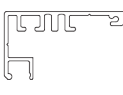
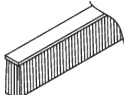
**Aufmontage**

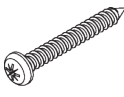

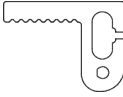
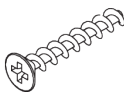
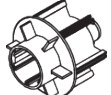
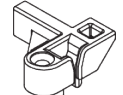
A: Systembreite

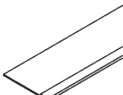
# KOMPONENTEN

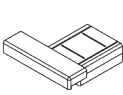
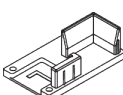
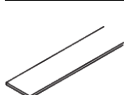
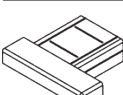
## A. STANDARD KOMPONENTEN

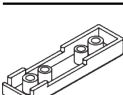
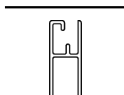
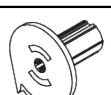
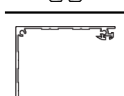
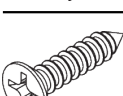
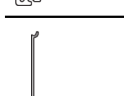
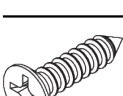
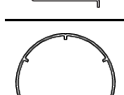
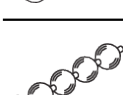
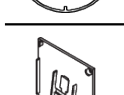
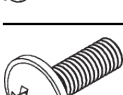
	<b>SG 4226</b> Doppelklebeband 30 mm		<b>SG 11009</b> Enddeckel rechts 110 mm		<b>SG 11060</b> Schaumklebeband
	<b>SG 4508</b> Bürste 5x7 mm		<b>SG 11011</b> Clip		<b>SG 11418</b> Seitliche Führungsschiene
	<b>SG 4509</b> Bürste 5x12 mm		<b>SG 11012</b> Clip für Kettenantrieb nature		<b>SG 11419</b> Seitliche Abdeckung
	<b>SG 6791</b> Linsenschraube 3.9x32		<b>SG 11020</b> Rohr Adapter Stütze 80 mm		<b>SG 11421</b> Zip-Profil
	<b>SG 6933</b> PT Senkkopfschraube KA25x16		<b>SG 11021</b> Rohr Adapter Kettenantrieb 80 mm		<b>SG 11473</b> Zip Führung links
	<b>SG 6936</b> PT Senkkopfschraube KA22x10		<b>SG 11025</b> Zip		<b>SG 11474</b> Zip Führung rechts
	<b>SG 6942</b> Linsenschraube KA30x8		<b>SG 11028</b> Enddeckel links		<b>SG 11475</b> Enddeckel links für Seitenführung
	<b>SG 10668</b> PVC Streifen 10 mm		<b>SG 11029</b> Enddeckel rechts		<b>SG 11476</b> Enddeckel rechts für Seitenführung
	<b>SG 10731</b> Kindersicherheitshalterset		<b>SG 11030</b> Deckel		
	<b>SG 10993</b> Beschwerung		<b>SG 11033</b> Kettenantrieb L		
	<b>SG 10998</b> Kassettengehäuse 110 mm		<b>SG 11034</b> Senkkopfschraube 3.5x16		
	<b>SG 10999</b> Kassettendeckel 110 mm		<b>SG 11035</b> Senkkopfschraube 2.2x9.5		
	<b>SG 11003</b> Rohr 80 mm		<b>SG 11040</b> Kugelfeder ø 4.5 mm, metall		
	<b>SG 11008</b> Enddeckel links, 110 mm		<b>SG 11059</b> Linsenschraube mit Flansch M4x12		

## **B. OPTIONALE KOMPONENTEN**

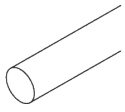

**SG 4951**

*Beschwerung ø 8 mm*



**SG 11052**

*Federset links 80 mm*



**SG 11053**

*Federset rechts 80 mm*

