

SG 4740

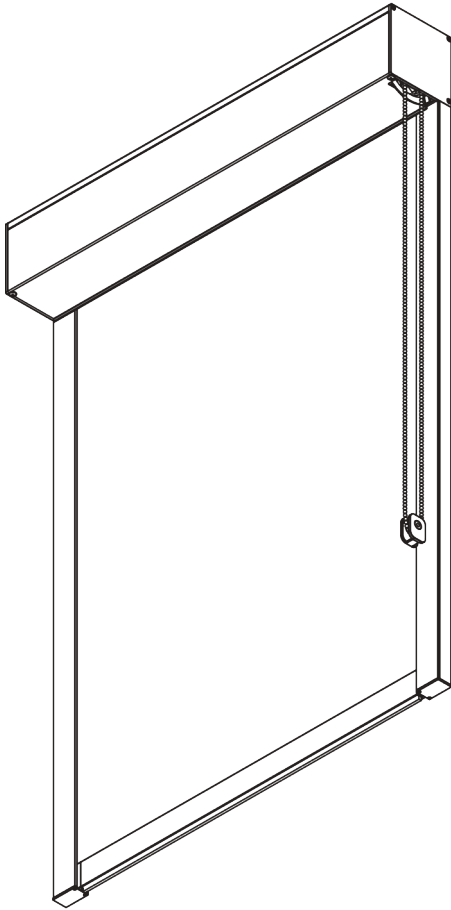

INFORMATION PRODUIT

- **Mode de commande:** Chaînette
- **Gamme:** L
- **Installation:** Plafond, Murale, Encastré
- **Couleurs:** Blanc RAL 9016, Noir RAL 9005, couleurs spéciales possible
- **Tissus:** Se référer à la collection tissu Silent Gliss

Caractéristiques:

- Technologie ZIP
- Chaînette acier inoxydable
- Entraînement démultiplié 2/1
- Glissière de guidage de 40 mm, préperçée

SPÉCIFICATION SYSTÈME

A. DIMENSIONS SYSTÈME



3 m



65 cm



3 m

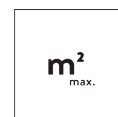

9 m²

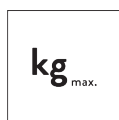

6 kg

B. PROFIL

Information profil

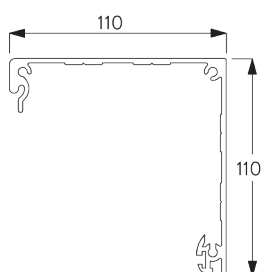

SG 10998

Boîtier 110 mm

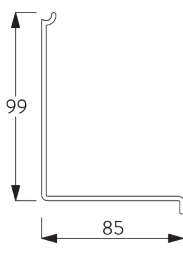

SG 10999

Couvercle 110 mm

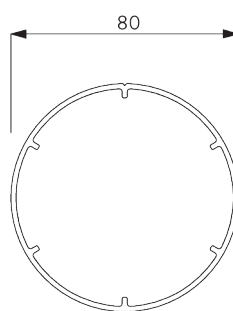

SG 11003

Profil ø 80 mm

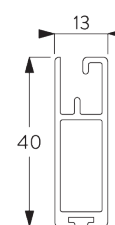

SG 10993

Barre de lestage rectangulaire

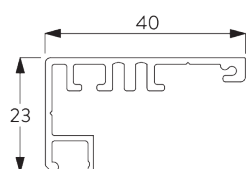

SG 11418

Profil de guidage

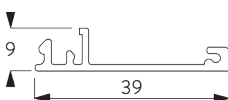

SG 11419

Couvercle de guidage

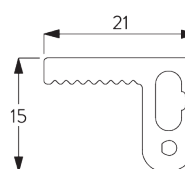

SG 11421

Profil Zip

C. PRISE DE MESURE

Installation en tableau

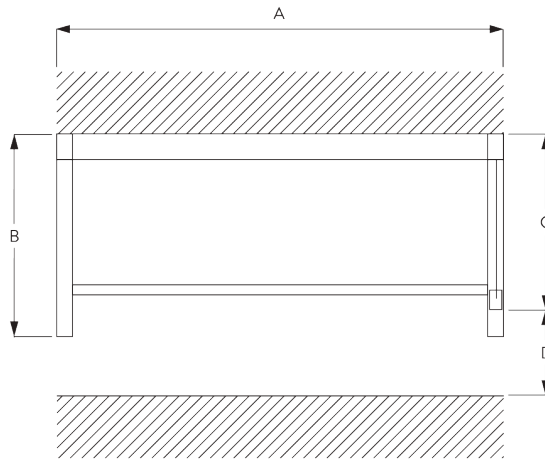

- A: Largeur du système
- B: Hauteur du système
- C: Hauteur chaînette
- D: Sécurité SG 10731. min. 150 cm du sol

Fixation murale

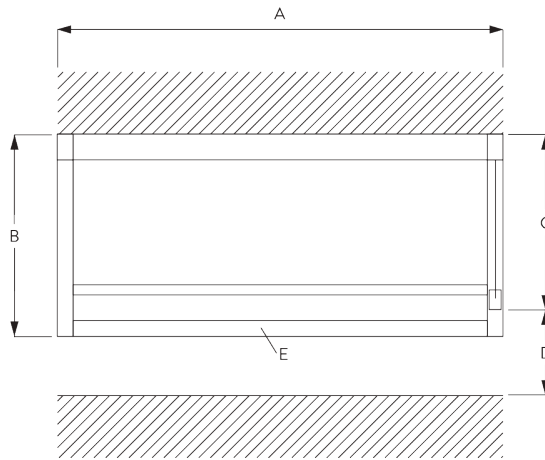

- A: Largeur du système
- B: Hauteur du système
- C: Hauteur chaînette
- D: Sécurité SG 10731. min. 150 cm du sol
- E: En option: Profil bas (SG 11418 / SG 11419)

INSTALLATION

A. INSTRUCTION DE POSE

Pour des informations détaillées, se référer au site web Silent Gliss.

Points de fixation en tableau

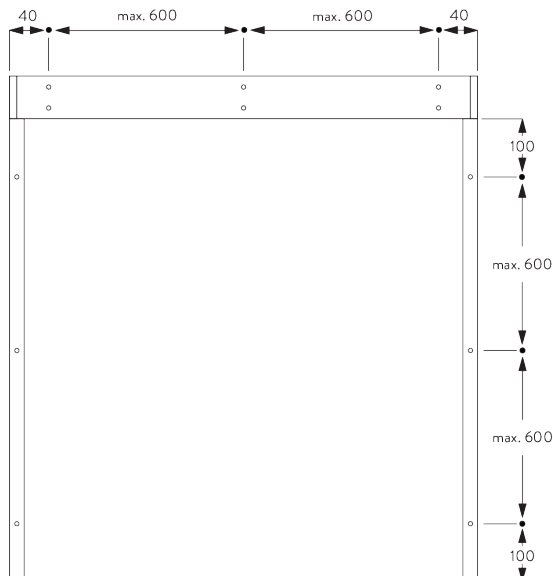

Points de fixation en pose murale

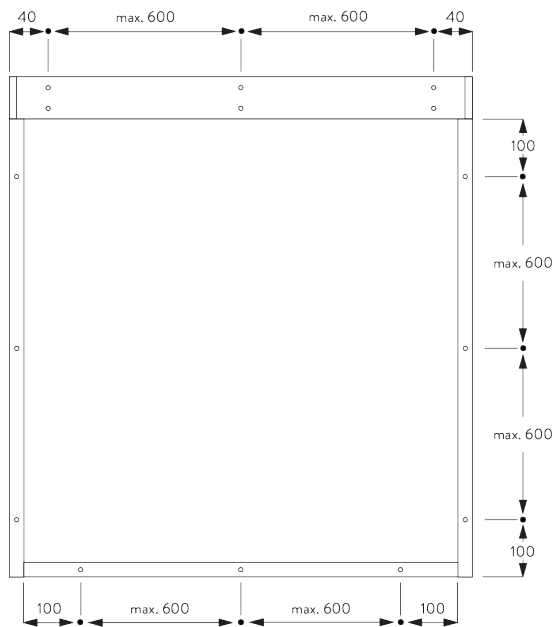

B. FIXATION PLAFOND

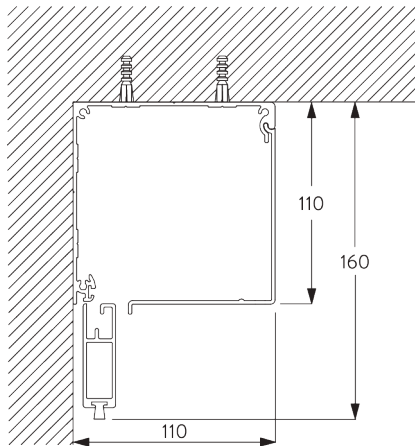

C. FIXATION MURALE

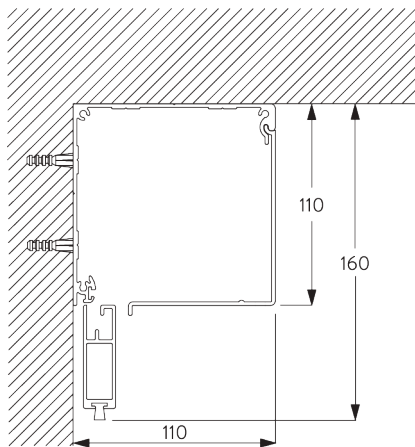

D. FIXATION
ENCASTRÉE

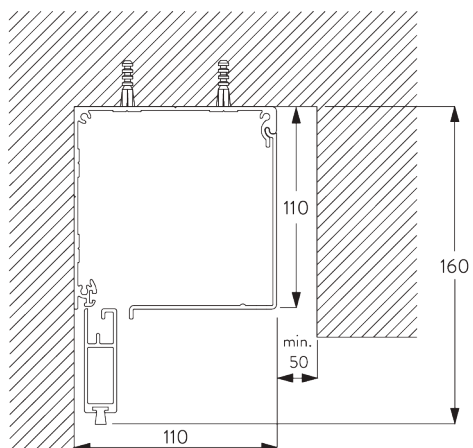

E. GLISSIÈRES DE
GUIDAGE
SG 11418 / SG 11419

Fixation en tableau

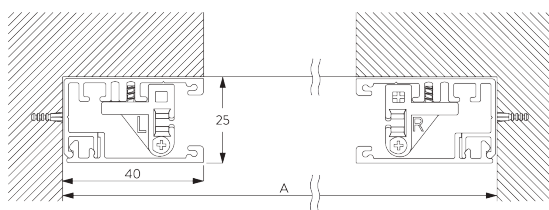

A: Largeur système



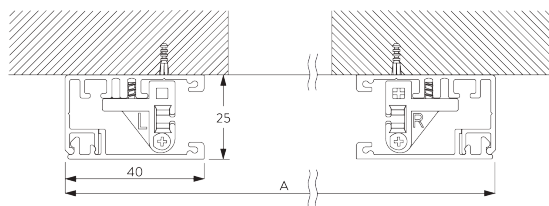







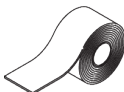

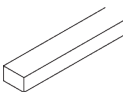
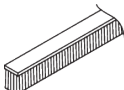

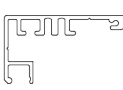
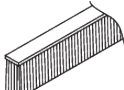





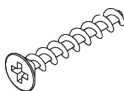
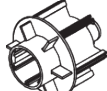
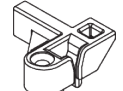

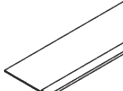

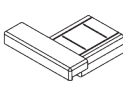
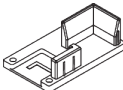
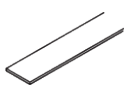
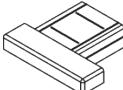
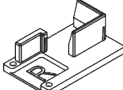
Fixation murale

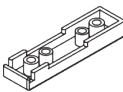
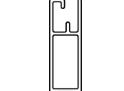
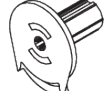

A: Largeur système

ACCESSOIRES

A. ACCESSOIRES STANDARDS

	SG 4226 Bande adhésif 30 mm		SG 11009 Embout boîtier droit 110 mm		SG 11060 Ruban adhésif
	SG 4508 Brosse 5x7		SG 11011 Clip support		SG 11418 Profil de guidage
	SG 4509 Brosse 5x12		SG 11012 Clip pour entraineur		SG 11419 Couvercle de guidage
	SG 6791 Vis 3.9x32		SG 11020 Adaptateur suport tube 80mm		SG 11421 Profil Zip
	SG 6933 Vis KA25x16		SG 11021 Adaptateur tube 80 mm chaînette		SG 11473 Embout guide Zip gauche
	SG 6936 Vis KA22x10		SG 11025 Bande Zip		SG 11474 Embout guide Zip droite
	SG 6942 Vis KA30x8		SG 11028 Embout barre de lestage gauche		SG 11475 Embout profil guidage gauche
	SG 10668 Bande adhésif 10 mm		SG 11029 Embout barre de lestage droite		SG 11476 Embout profil guidage droite
	SG 10731 Poulie de sécurité pour chaînette & cordon		SG 11030 Cache barre de lestage		
	SG 10993 Barre de lestage rectangulaire		SG 11033 Poulie chaînette L		
	SG 10998 Boîtier 110 mm		SG 11034 Vis 3.5x16		
	SG 10999 Couvercle 110 mm		SG 11035 Vis 2.2x9.5		
	SG 11003 Profil ø 80 mm		SG 11040 Chaîne métallique ø 4.5 mm		
	SG 11008 Embout boîtier gauche 110 mm		SG 11059 Vis M4x12		

B. ACCESSOIRES EN OPTION

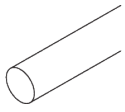

SG 4951

Contrepoids acier



SG 11052

Set ressort gauche 80mm



SG 11053

Set ressort droit 80mm

