

SG 1020

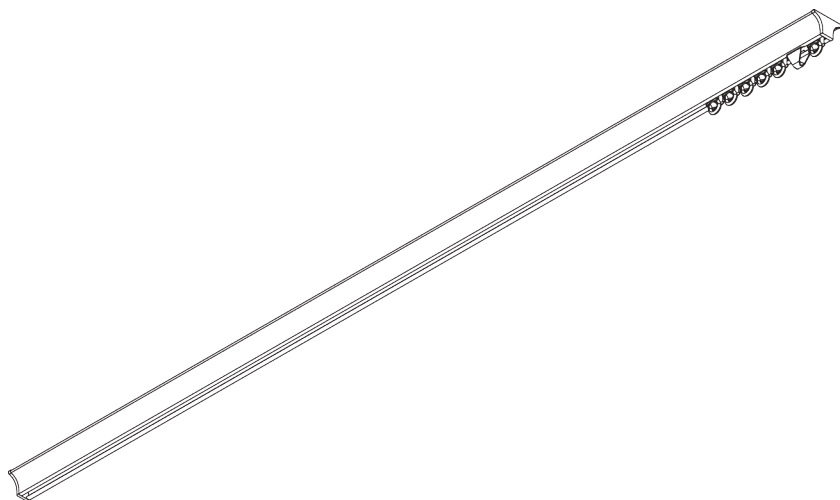

PRODUKTINFORMATIONEN

- **Bedienung:** Hand
- **Grösse:** S
- **Montage:** Decke
- **Farben:** weiss RAL 9016 oder Aluminium farblos eloxiert, Sonderfarben möglich
- **Stoffe:** siehe Silent Gliss Stoffkollektion

Merkmale:

- Symmetrisches Trichter Design
- Biegbar

SYSTEMSPEZIFIKATIONEN

A. MASSE / GEWICHT



10 kg

B. PROFIL

Profil- und
Biegeinformationen

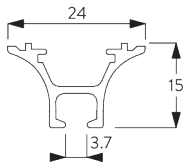

SG 6822

Profil Funnel

Radius: >27 cm

C. MASSAUFNAHME

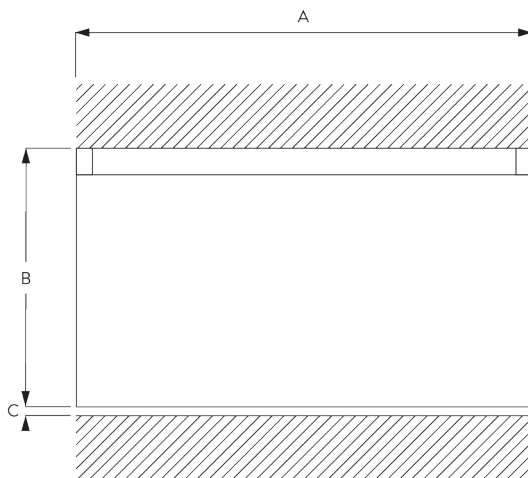

A: Systembreite

B: Systemhöhe

C: Abstand zwischen Boden und Behang

MONTAGE

A. MONTAGE- INFORMATIONEN

Detaillierte Montageinformationen siehe
Silent Gliss Website

Montagepunkte

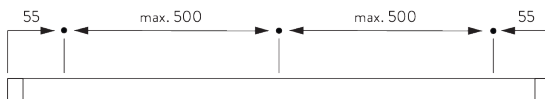

Werkzeug

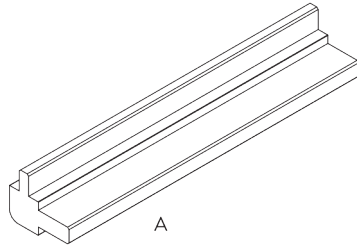

A: Funnel Montage Werkzeug SG 6827

Für Montage / Demontage des Funnel Profils.

**B. DECKEN-
MONTAGE**

Clip SG 11236

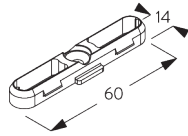
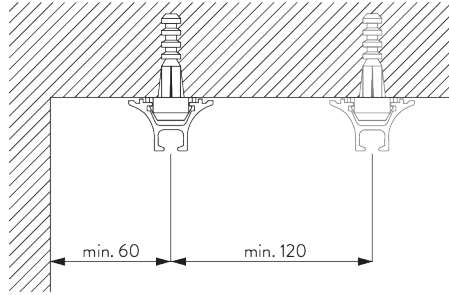

SG 11236

Clip

KOMPONENTEN

A. STANDARD KOMPONENTEN



SG 3070

Ösenfeststeller

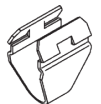

SG 3085

Verschlussfeder



SG 3535

Gleiter



SG 6822

Profil Funnel



SG 6824

Enddeckel

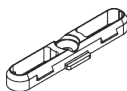

SG 11236

Clip

B. OPTIONALE KOMPONENTEN



SG 3012

Haken

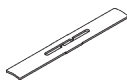

SG 3062

Profilverbinder



SG 3511

Gleiter



SG 3533

Gleiter



SG 3534

Gleiter 3533 an der Stange



SG 3537

Gleiter

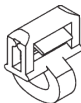

SG 3547

Click-Gleiter

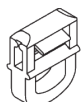

SG 3548

Gleiter



SG 3549

Klickgleiter mit Haken



SG 3555

Haken



SG 3582

Haken

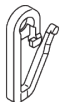

SG 3598

Öse



SG 3599

Haken



SG 10430

Schleuderstab 50 cm

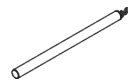

SG 10431

Schleuderstab 75 cm

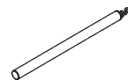

SG 10432

Schleuderstab 100 cm



SG 10433

Schleuderstab 125 cm

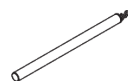

SG 10434

Schleuderstab 150 cm

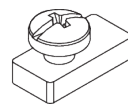

SG 11335

Feststeller