

SG 1020

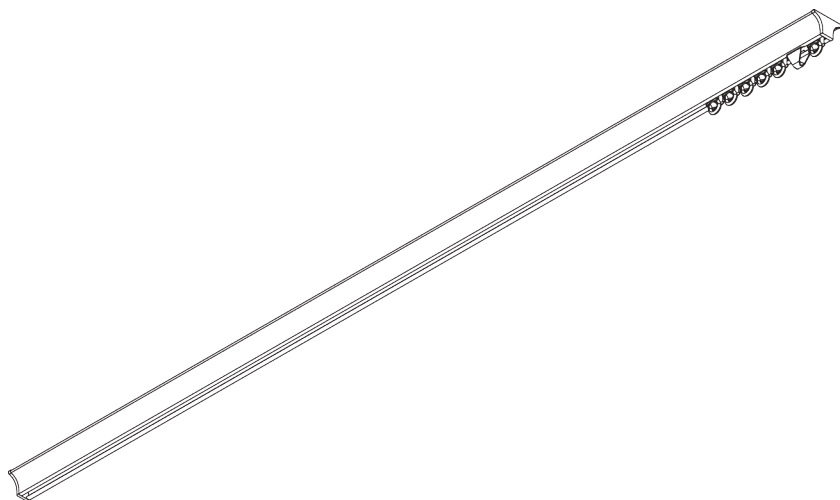

INFORMATION PRODUIT

- **Mode de commande:** Tirage main
- **Gamme:** S
- **Installation:** Plafond
- **Couleurs:** Blanc RAL 9016 ou Aluminium, couleurs spéciales possibles
- **Tissus:** Se référer à la collection tissu Silent Gliss

Caractéristiques:

- *Forme d'entonnoir (Funnel design)*
- Cintrable

SPÉCIFICATION SYSTÈME

A. POIDS DU SYSTÈME

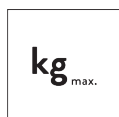

10 kg

B. PROFIL

Profil et information de cintrage

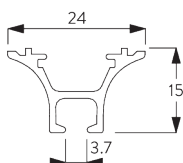

SG 6822

Profil Funnel

Rayon >27 cm

C. PRISE DE MESURE

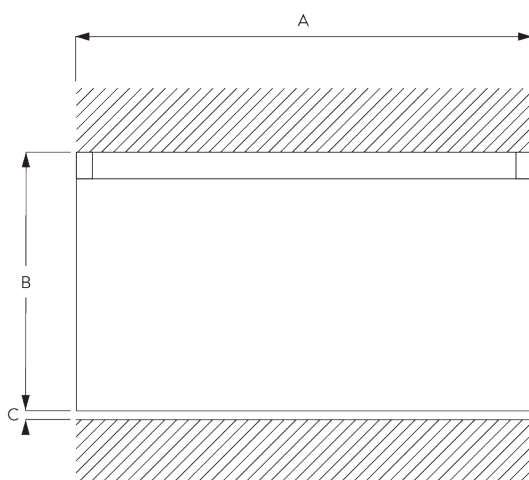

A: Largeur système

B: Hauteur système

C: Distance entre bas du rideau et le sol

INSTALLATION

A. INSTRUCTION DE POSE

Pour des informations détaillées, se référer au site web Silent Gliss.

Points de fixation

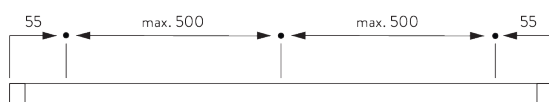

Outils d'installation

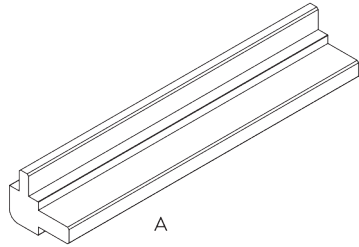

A: Outil d'installation SG 6827

Pour le montage / démontage du profil Funnel.

B. FIXATION PLAFOND

Clip SG 11236

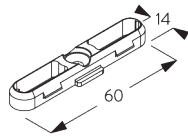
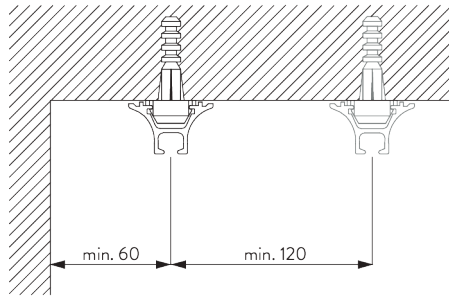

SG 11236

Clip

ACCESSOIRES

A. ACCESSOIRES STANDARDS



SG 3070

Fixateur avec oeillet

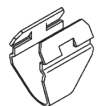

SG 3085

Ressort d'arrêt



SG 3535

Glisseur



SG 6822

Profil Funnel



SG 6824

Embout

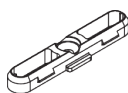

SG 11236

Clip

B. ACCESSOIRES EN OPTION



SG 3012

Agrafe à coudre

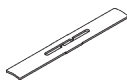

SG 3062

Pièce de raccord



SG 3511

Glisseur à coudre



SG 3533

Glisseur



SG 3534

Glisseur 3533 en barrette de 20 unités



SG 3537

Glisseur



SG 3547

Glisseur

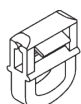

SG 3548

glisseur clipsable



SG 3549

Glisseur clic avec agrafe



SG 3555

Agrafe ajustable



SG 3582

Agrafe Delrin

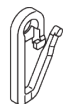

SG 3598

Agrafe



SG 3599

Crochet pour galon à froncer



SG 10430

Lance rideau aluminium avec crochet, 50cm

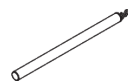

SG 10431

Lance rideau aluminium avec crochet, 75 cm

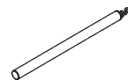

SG 10432

Lance rideau aluminium avec crochet, 100 cm

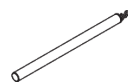

SG 10433

Lance rideau aluminium avec crochet, 125 cm

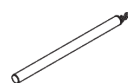

SG 10434

Lance rideau aluminium avec crochet, 150 cm

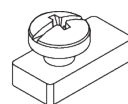

SG 11335

Arrêt