

SG 6815

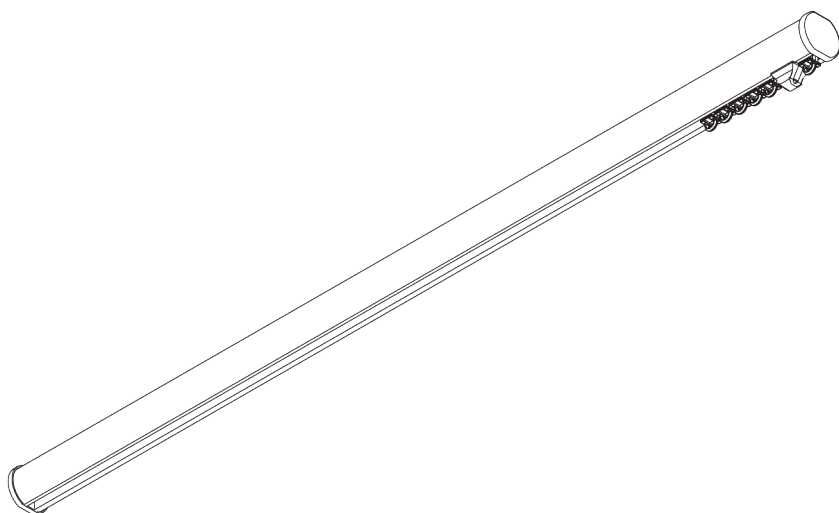

INFORMATION PRODUIT

- **Mode de commande:** Tirage main
- **Gamme:** S - M
- **Installation:** Plafond, murale
- **Couleurs:** Blanc RAL 9016 ou Aluminium, couleurs spéciales possibles
- **Tissus:** Se référer à la collection tissu Silent Gliss

Caractéristiques:

- Glisseurs Bi-Composants
- Option Glisseurs Wave Bi-Composants
- Cintrable

SPÉCIFICATION SYSTÈME

A. PROFIL

Profil et information de cintrage

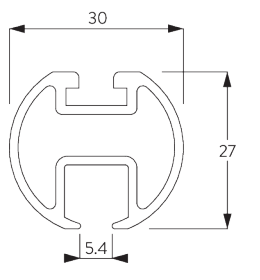

SG 6103p

Profil

Rayon: >25 cm

B. PRISE DE MESURE

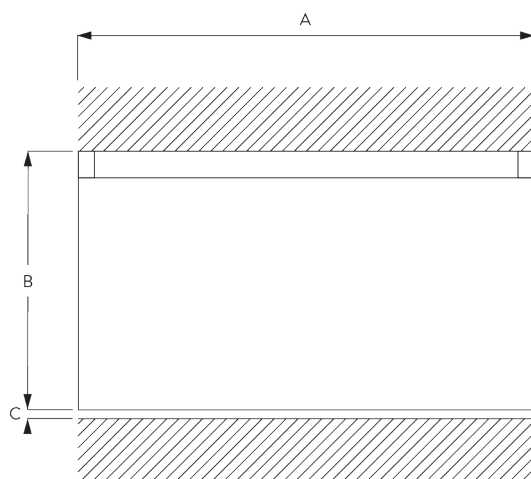

A: Largeur système

B: Hauteur système

C: Distance entre bas du rideau et le sol

INSTALLATION

A. INSTRUCTION DE POSE

Pour des informations détaillées, se référer au site web Silent Gliss.

Points de fixation

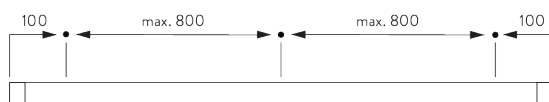

B. FIXATION
PLAFOND

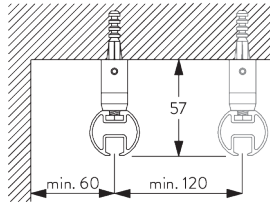

Mini suspension SG 6175

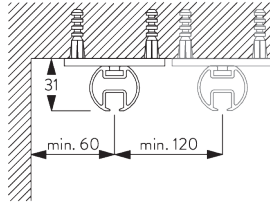

Support SG 6124

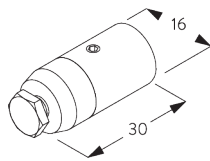

SG 6175
Mini suspension

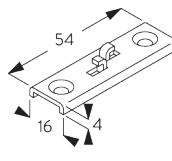

SG 6124
Support

C. FIXATION
MURALE

Smart Fix

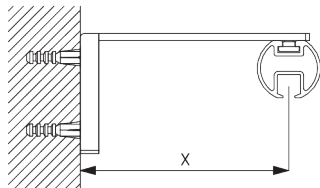

Smart Fix avec fente SG 11206 - SG 11208:
Vis SG 10492 (M4x8) nécessaire.

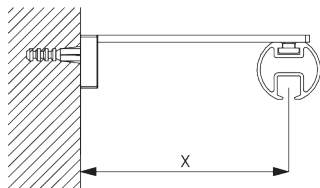

Square Smart Fix avec fente SG 11216 - SG 11218:
Vis SG 10492 (M4x8) nécessaire.

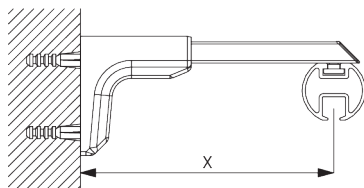

Universal Smart Fix SG 11154 - SG 11156:
Vis SG 11131 (M4x6) nécessaire.

Smart Fix	X mm
SG 11206 / SG 11216	33 - 51
SG 11207 / SG 11217	53 - 71
SG 11208 / SG 11218	73 - 91
SG 11154	102 - 130
SG 11155	132 - 160
SG 11156	182 - 210

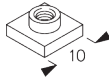

SG 6117
Ecrou



SG 10492
Vis M4x8



SG 11131
Vis M4x6

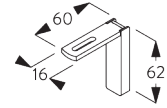

SG 11206
Smart Fix 60 mm avec fente

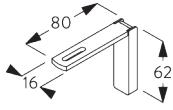

SG 11207
Smart Fix 80 mm avec fente

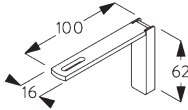

SG 11208
Smart Fix 100 mm avec fente

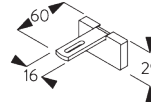

SG 11216
Square Smart Fix 60 mm avec fente

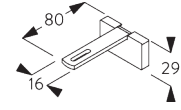

SG 11217
Square Smart Fix 80 mm avec fente

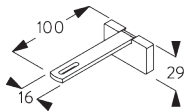

SG 11218
Square Smart Fix 100 mm avec fente

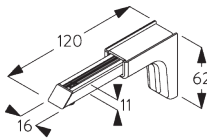

SG 11154
Universal Smart Fix 120 mm

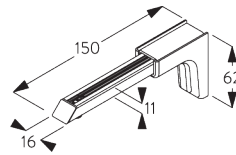

SG 11155
Universal Smart Fix 150 mm

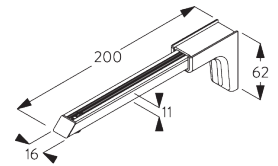

SG 11156
Universal Smart Fix 200 mm

OPTIONS SYSTÈME

A. WAVE

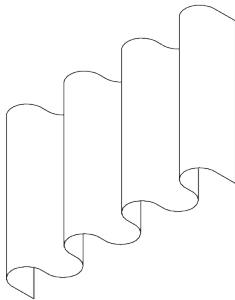

SG 11295

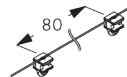

SG 11302

Composants Standards:

- SG 11295 Vis d'arrêt
- SG 11302 Glisseurs Wave bi-composants 80 mm

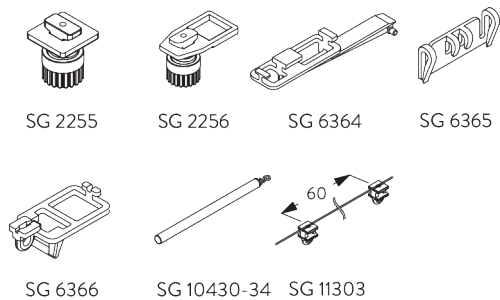

Composants en option:

- SG 2255 Frein
- SG 2256 Frein
- SG 6364 Extension Wave
- SG 6365 Crochet Wave
- SG 6366 Chariot Wave pour lance rideau
- SG 10430-34 Lance rideau
- SG 11303 Glisseur Wave bi-composants 60 mm

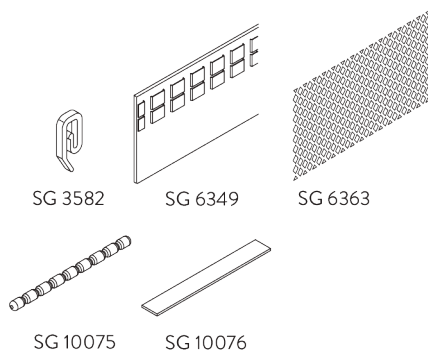

Composants de rideaux:

- SG 3582 Crochet
- SG 6349 Ruban Wave transparent
- SG 6363 Ruban à repasser
- SG 10075 Fil à plomb 50 gr/m
- SG 10076 Barre de lestage

Paquet rideau Wave - Glisseur Bi-composants (standard)

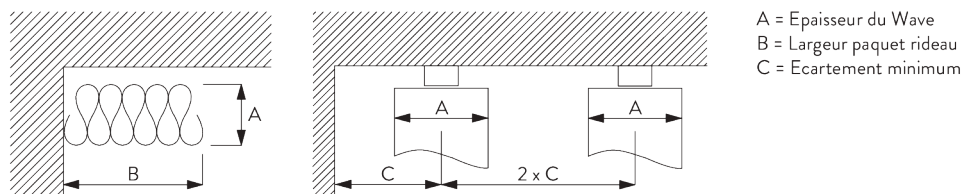

A = Epaisseur du Wave
 B = Largeur paquet rideau
 C = Ecartement minimum

Glisseur Bi-composants SG 11302	Nombre de poches entre crochets	Ampleur rideau Approximative	Epaisseur du Wave A	Largeur paquet rideau B*	Ecartement minimum C
80	6	~2.1	140	180 mm par ml de tringle	90
80	7	~2.3	160	180 mm par ml de tringle	100

Glisseur Bi-composants SG 11303	Nombre de poches entre crochets	Ampleur rideau Approximative	Epaisseur du Wave A	Largeur paquet rideau B*	Ecartement minimum C
60	4	~2.1	100	230 mm par ml de tringle	70
60	5	~2.3	120	230 mm par ml de tringle	80

*Largeur paquet rideau B lors de l'utilisation du bras d'extension SG 6364 augmente de 150 mm par rideau!

ACCESSOIRES

A. ACCESSOIRES STANDARDS



SG 6065

Fixateur avec oeillet

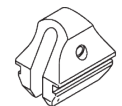

SG 6086

Ressort d'arrêt delrin



SG 6103p

Profil

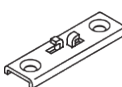

SG 6124

Support

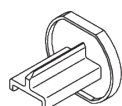

SG 6630

Embout (ø32.5mm)

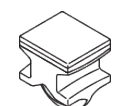

SG 11305

Glisseur Bi-composants pour couture directe

B. ACCESSOIRES EN OPTION

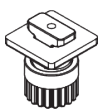

SG 2255

Frein

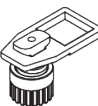

SG 2256

Frein



SG 3012

Agrafe à coudre



SG 3581

Agrafe

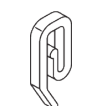

SG 3582

Agrafe Delrin

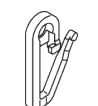

SG 3598

Agrafe



SG 3599

Crochet pour galon à froncer



SG 6004

Oeillet pour rouleur



SG 6053

Ressort d'arrêt



SG 6057

Glisseur



SG 6082

Glisseur à coudre



SG 6094

Rouleur



SG 6098

Rouleur

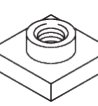

SG 6117

Ecrou

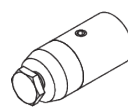

SG 6175

Mini suspension



SG 6240

Rouleur



SG 6283

Rouleur

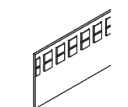

SG 6349

Ruban Wave transparent



SG 6363

Ruban à repasser

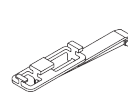

SG 6364

Extension

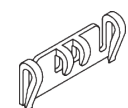

SG 6365

Crochet Wave

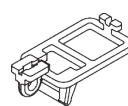

SG 6366

Chariot pour lance rideau

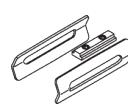

SG 6635

Pièce de raccord

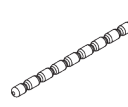

SG 10075

Fil à plomb 50 gr/m

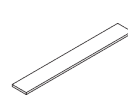

SG 10076

Barre de lestage

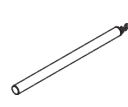

SG 10430

Lance rideau aluminium avec crochet, 50cm

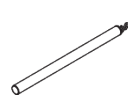

SG 10431

Lance rideau aluminium avec crochet, 75 cm

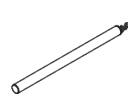

SG 10432

Lance rideau aluminium avec crochet, 100 cm

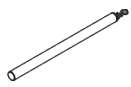

SG 10433
Lance rideau aluminium avec
crochet, 125 cm

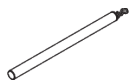

SG 10434
Lance rideau aluminium avec
crochet, 150 cm

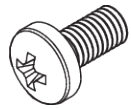

SG 10492
Vis M4x8



SG 11131
Vis M4x6

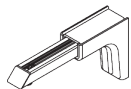

SG 11154
Universal Smart Fix 120 mm

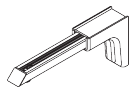

SG 11155
Universal Smart Fix 150 mm

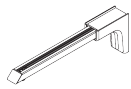

SG 11156
Universal Smart Fix 200 mm

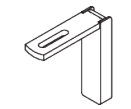

SG 11206
Smart Fix 60 mm avec fente

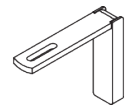

SG 11207
Smart Fix 80 mm avec fente

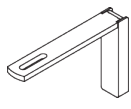

SG 11208
Smart Fix 100 mm avec fente

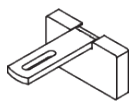

SG 11216
Square Smart Fix 60 mm avec fente

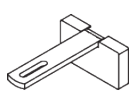

SG 11217
Square Smart Fix 80 mm avec fente

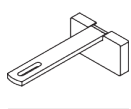

SG 11218
Square Smart Fix 100 mm avec
fente

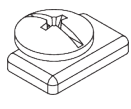

SG 11295
Arrêt

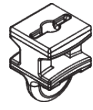

SG 11300
Glisseur Bi-composants



SG 11301
Glisseur Bi-composants en barrette

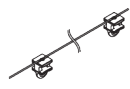

SG 11302
Glisseur Wave Bi-composants 80
mm

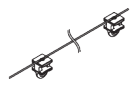

SG 11303
Glisseur Wave Bi-composants 60
mm

