

SG 6870

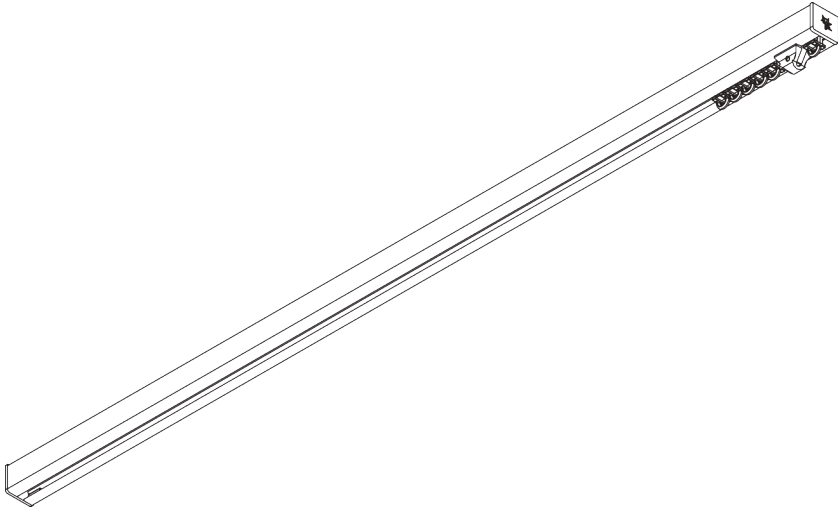
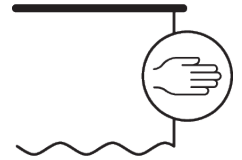

PRODUKTINFORMATIONEN

- **Bedienung:** Hand
- **Grösse:** M - L
- **Montage:** Decke, Wand, Nut
- **Farben:** weiss RAL 9016, schwarz RAL 9005 oder Aluminium farblos eloxiert, Sonderfarben möglich (Nutprofil nur weiss RAL 9016, schwarz RAL 9005 oder Sonderfarbe)
- **Stoffe:** siehe Silent Gliss Stoffkollektion

Merkmale:

- 2-Komponenten-Gleiter-Technologie (2C)
- Wave (2C)
- Biegbar
- Biegbares Nutprofil

SYSTEMSPEZIFIKATIONEN

A. PROFIL

Profil- und
Biegeinformationen

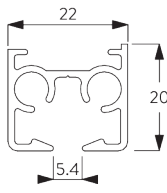

SG 11190

Profil

✓ Radius:
>26 cm

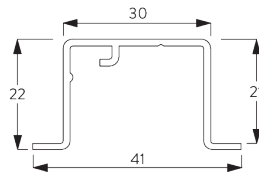

SG 11230

Nutprofil

✓ Radius:
>50 cm

B. MASSAUFNAHME

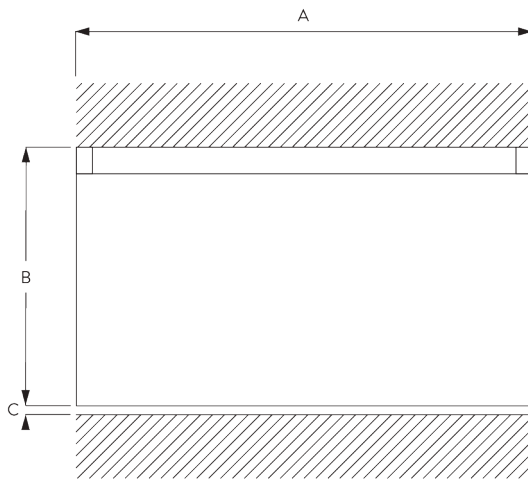

A: Systembreite

B: Systemhöhe

C: Abstand zwischen Boden und Behang

MONTAGE

A. MONTAGE- INFORMATIONEN

Montagepunkte

Detaillierte Montageinformationen siehe
Silent Gliss Website

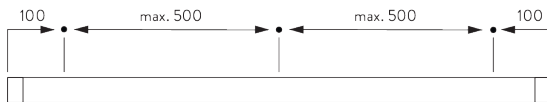

B. DECKEN- MONTAGE

Spanner SG 3825

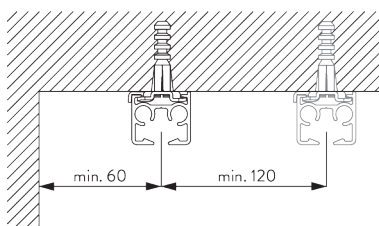

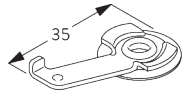

SG 3825

Spanner

Träger SG 3826

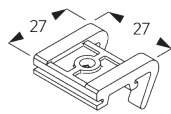
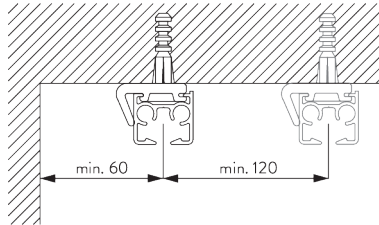

SG 3826

Träger

Träger SG 3832

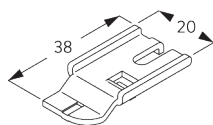
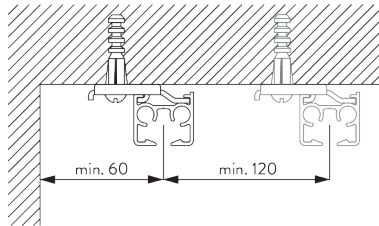

SG 3832

Träger

C. WANDMONTAGE

Smart Fix

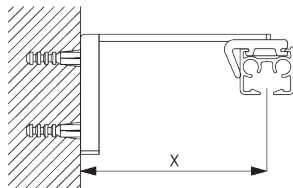

Smart Fix SG 11200 - SG 11205 und Träger SG 3826:
Benötigt Schraube SG 10492 (M4x8).

Smart Fix	X mm (SG 3826 / SG 3825)	X mm (SG 3832)
SG 11200 / SG 11210	52	70
SG 11201 / SG 11211	72	90
SG 11202 / SG 11212	92	110
SG 11203 / SG 11213	112	130
SG 11204 / SG 11214	142	160
SG 11205 / SG 11215	192	210
SG 11154	102-130	120-148
SG 11155	132-160	150-178
SG 11156	182-210	200-228

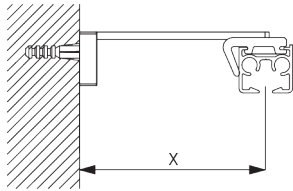

Square Smart Fix SG 11210 - SG 11215 und Träger SG 3826:
Benötigt Schraube SG 10492 (M4x8).

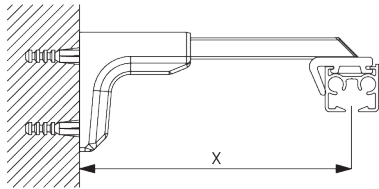

Universal Smart Fix SG 11154 - SG 11156 und Träger SG 3826:
Benötigt Schraube SG 10277 (M4x12).

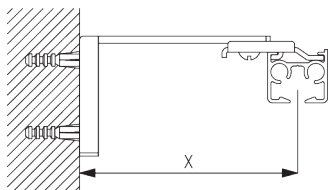

Smart Fix SG 11200 - SG 11205 und Träger SG 3832:
Benötigt Schraube SG 10492 (M4x8).

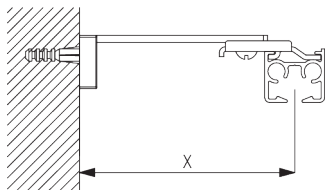

Square Smart Fix SG 11210 - SG 11215 und Träger SG 3832:
Benötigt Schraube SG 10492 (M4x8).

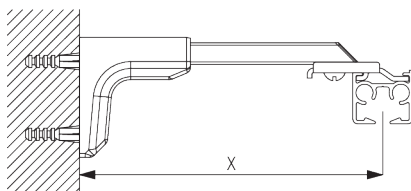

Universal Smart Fix SG 11154 - SG 11156 und Träger SG 3832:
Benötigt Schraube SG 10407 (M4x10).

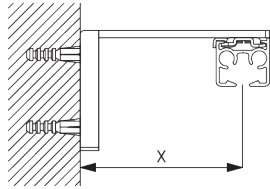

Smart Fix SG 11200 - SG 11205 und Spanner SG 3825:
Benötigt Schraube SG 10074 (M4x8).

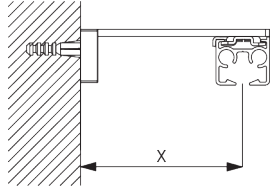

Square Smart Fix SG 11210 - SG 11215 und Spanner SG 3825:
Benötigt Schraube SG 10074 (M4x8).

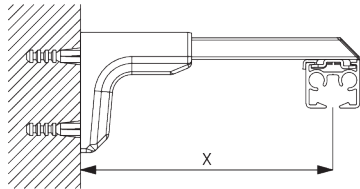

Universal Smart Fix SG 11154 - SG 11156 und Spanner SG 3825:
Benötigt Schraube SG 11158 (M4x12).

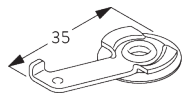

SG 3825
Spanner

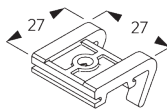

SG 3826
Träger

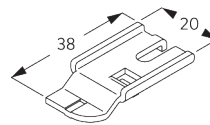

SG 3832
Träger



SG 10074
Senkschraube M4x8



SG 10277
Linsenschraube M4x12



SG 10407
Linsenschraube M4x10



SG 10492
Linsenschraube M4x8



SG 11158
Senkschraube M4x12

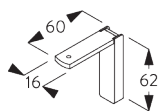

SG 11200
Smart Fix 60 mm

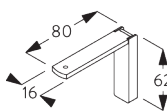

SG 11201
Smart Fix 80 mm

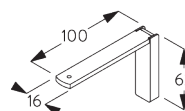

SG 11202
Smart Fix 100 mm

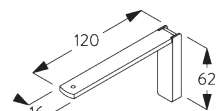

SG 11203
Smart Fix 120 mm

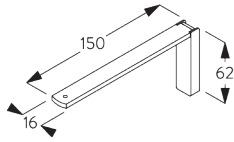

SG 11204

Smart Fix 150 mm

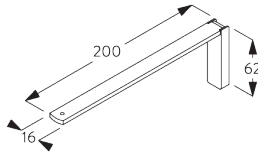

SG 11205

Smart Fix 200 mm

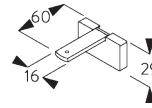

SG 11210

Square Smart Fix 60 mm

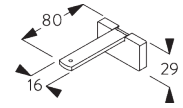

SG 11211

Square Smart Fix 80 mm

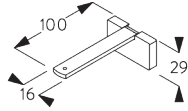

SG 11212

Square Smart Fix 100 mm

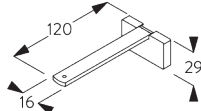

SG 11213

Square Smart Fix 120 mm

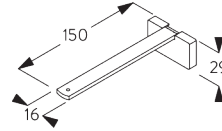

SG 11214

Square Smart Fix 150 mm

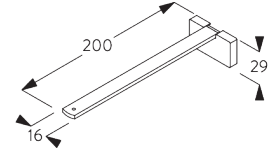

SG 11215

Square Smart Fix 200 mm

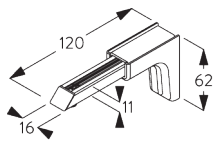

SG 11154

Universal Smart Fix 120 mm

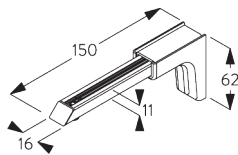

SG 11155

Universal Smart Fix 150 mm

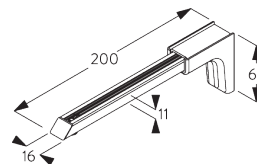

SG 11156

Universal Smart Fix 200 mm

Träger SG 3836

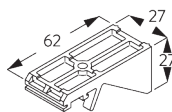
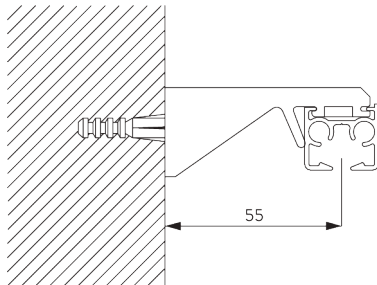

SG 3836

Träger

D. NUTMONTAGE

Nutprofil SG 11230

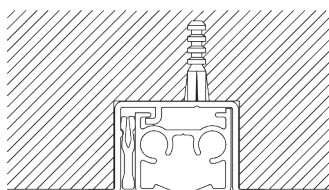

Eine Klammer SG 10157 pro Montagepunkt.
 Detaillierte Nutmontage siehe Silent Gliss Website.

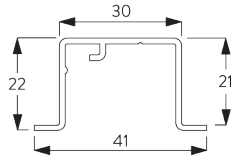

SG 11230
Nutprofil

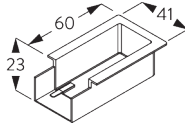

SG 11238
Nutmaske

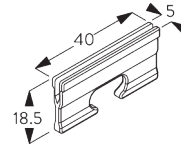

SG 10157
Klammer

SYSTEMOPTIONEN

A. WAVE

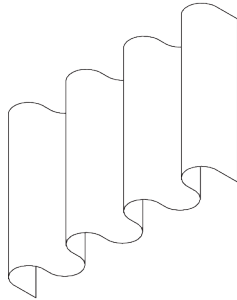

SG 11295

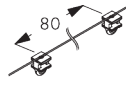

SG 11302



SG 2255



SG 2256

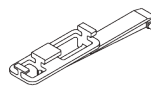

SG 6364



SG 6365

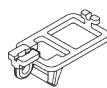

SG 6366

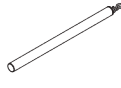

SG 10430-34

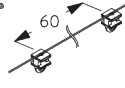

SG 11303

Standard Komponenten:

- SG 11295 Festssteller
- SG 11302 Wave-2C-Gleiterkordel 80 mm

Optionale Komponenten:

- SG 2255 Bremse
- SG 2256 Bremse
- SG 6364 Wave Verlängerung
- SG 6365 Wave Hänger
- SG 6366 Wave Träger für Schleuderstab
- SG 10430-34 Schleuderstab
- SG 11303 Wave-2C-Gleiterkordel 60 mm

Vorhang Komponenten:

- SG 3582 Haken
- SG 6349 Wave Vorhangband
- SG 6363 Wave Bügelband
- SG 10075 Bleischnur 50 gr/m
- SG 10076 Beschwerung Seitensaum

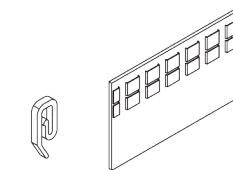

SG 3582

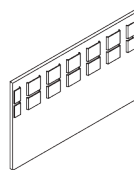

SG 6349

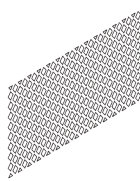

SG 6363

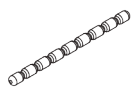

SG 10075



SG 10076

Wave Paketbreite - 2C-Gleiterkordel (Standard Komponenten)

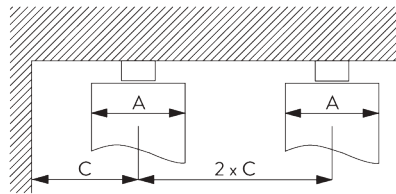
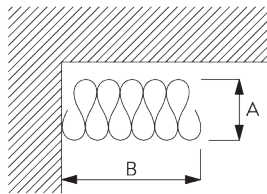

A = Pakettiefe
B = Paketbreite
C = Min. Abstand





2C-Gleiterkordel SG 11302	Zwischen- laschen	Stoffzugabe	Pakettiefe A	Paketbreite B*	Min. Abstand C
80	6	~2.1	140	180 pro Meter System	90
80	7	~2.3	160	180 pro Meter System	100

2C-Gleiterkordel SG 11303	Zwischen- laschen	Stoffzugabe	Pakettiefe A	Paketbreite B*	Min. Abstand C
60	4	~2.1	100	230 pro Meter System	70
60	5	~2.3	120	230 pro Meter System	80





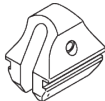
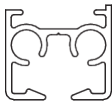
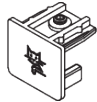





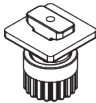

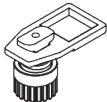
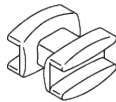

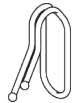



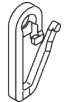

*Paketgröße B vergrößert sich um 150 mm pro Vorhangpaket bei Verwendung des optionalen Verlängerungsarms SG 6364!

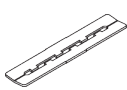
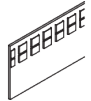
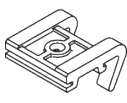
KOMPONENTEN

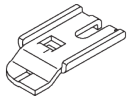
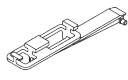
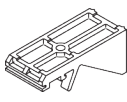
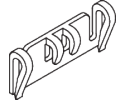
A. STANDARD KOMPONENTEN

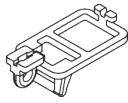
	SG 3825 Spanner
	SG 6065 Feststeller
	SG 6086 Verschlussfeder
	SG 11190 Profil
	SG 11233 Enddeckel
	SG 11305 2C-Gleiter für direktes Annähen

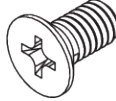
B. OPTIONALE KOMPONENTEN

	SG 2255 Brems		SG 6057 Gleiter
	SG 2256 Brems		SG 6082 Gleiter
	SG 3012 Haken		SG 6094 Roller
	SG 3581 Haken		SG 6098 Roller
	SG 3582 Haken		SG 6146 Haken
	SG 3598 Öse		SG 6240 Roller
	SG 3599 Haken		SG 6283 Roller
	SG 3802 Profilverbinder		SG 6349 Wave Vorhangband
	SG 3826 Träger		SG 6363 Wave Bügelband
	SG 3832 Träger		SG 6364 Wave Verlängerungsarm
	SG 3836 Träger		SG 6365 Wave Hänger
	SG 6004 Öse		SG 6366 Wave Mitnehmer für Schleuderstab
	SG 6005 Haken		SG 10074 Senkschraube M4x8
	SG 6053 Verschlußfeder		SG 10075 Bleischnur 50 gr/m

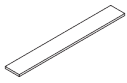

SG 10076

Beschwerung Seitensaum

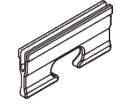

SG 10157

Klammer

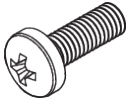

SG 10277

Linsenschraube M4x12

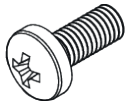

SG 10407

Linsenschraube M4x10

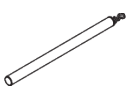

SG 10430

Schleuderstab 50 cm

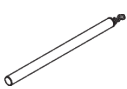

SG 10431

Schleuderstab 75 cm

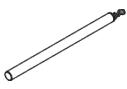

SG 10432

Schleuderstab 100 cm

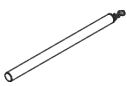

SG 10433

Schleuderstab 125 cm



SG 10434

Schleuderstab 150 cm



SG 10492

Linsenschraube M4x8

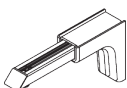

SG 11154

Universal Smart Fix 120 mm

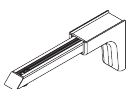

SG 11155

Universal Smart Fix 150 mm

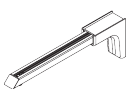

SG 11156

Universal Smart Fix 200 mm

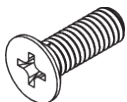

SG 11158

Senkschraube M4x12

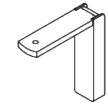

SG 11200

Smart Fix 60 mm

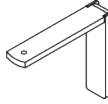

SG 11201

Smart Fix 80 mm

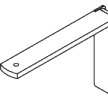

SG 11202

Smart Fix 100 mm

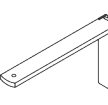

SG 11203

Smart Fix 120 mm

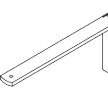

SG 11204

Smart Fix 150 mm

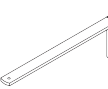

SG 11205

Smart Fix 200 mm

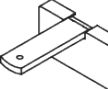

SG 11210

Square Smart Fix 60 mm

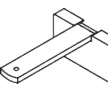

SG 11211

Square Smart Fix 80 mm

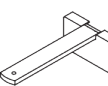

SG 11212

Square Smart Fix 100 mm

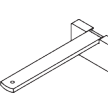

SG 11213

Square Smart Fix 120 mm

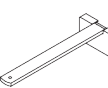

SG 11214

Square Smart Fix 150 mm

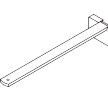

SG 11215

Square Smart Fix 200 mm

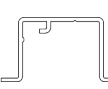

SG 11230

Nutprofil

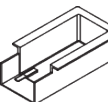

SG 11238

Nutmaske

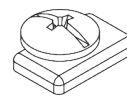

SG 11295

Feststeller

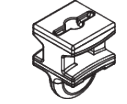

SG 11300

2C-Gleiter



SG 11301

2C-Gleiter am Strip

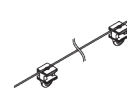

SG 11302

Wave-2C-Gleiterkordel 80 mm

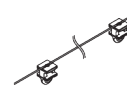

SG 11303

Wave-2C-Gleiterkordel 60 mm

