

SG 2700

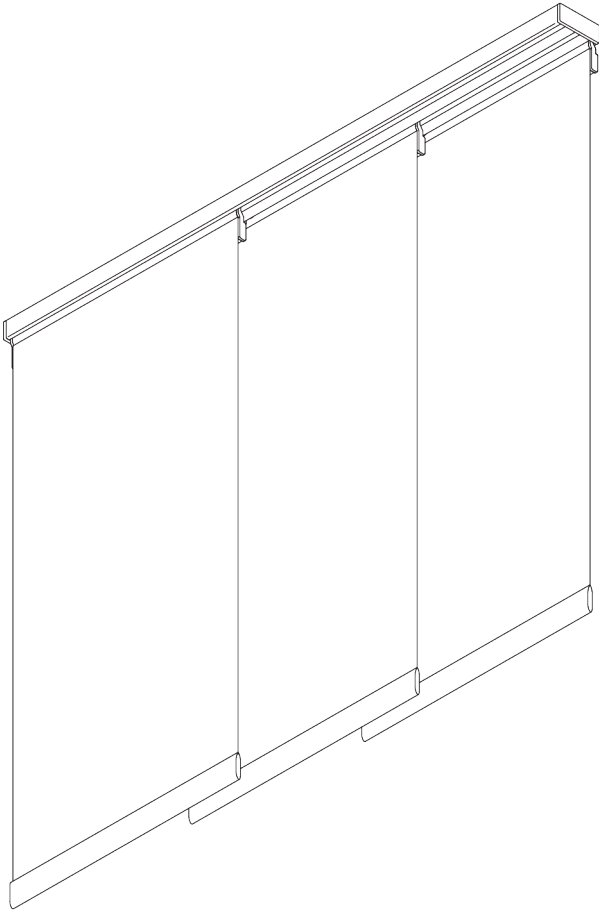

PRODUKTINFORMATIONEN

- **Bedienung:** Hand
- **Grösse:** S - L
- **Montage:** Decke, Wand, Nut
- **Farben:** weiss RAL 9016 oder Aluminium farblos eloxiert, Sonderfarben möglich
- **Stoffe:** siehe Silent Gliss Stoffkollektion

Merkmale:

- 2-Komponenten-Roller-Technologie (2C)
- Leise und leichtgängig
- Aluminium Paneelwagen
- Frei verschiebbare oder verbundene Paneele

SYSTEMSPEZIFIKATIONEN

A. MASSE / GEWICHT



Paneele frei verschiebbar:
unlimitiert
Paneele verbunden: 6 m

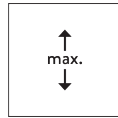

4 m



Max. 2 kg pro m
Panneelwagen

B. PROFIL

Profilinformationen

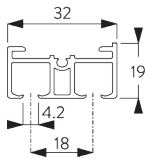

SG 10122

Profil 2-läufig

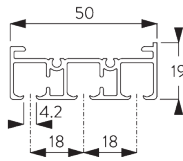

SG 10123

Profil 3-läufig

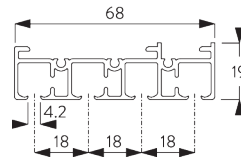

SG 10124

Profil 4-läufig

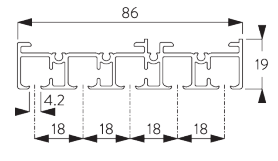

SG 10125

Profil 5-läufig

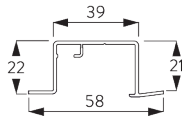

SG 10172

Nutprofil 2-läufig

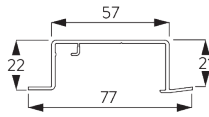

SG 10173

Nutprofil 3-läufig

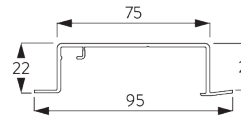

SG 10174

Nutprofil 4-läufig

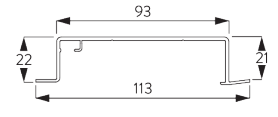

SG 10175

Nutprofil 5-läufig

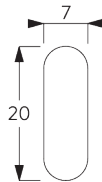

SG 2004

Beschwerung 20x7 mm

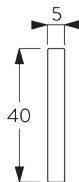

SG 2005

Beschwerung 40x5 mm

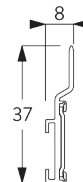

SG 10230

Panneelwagen alu

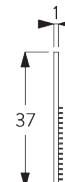

SG 10250

Panneelwagen transparent

C. MASSAUFNAHME

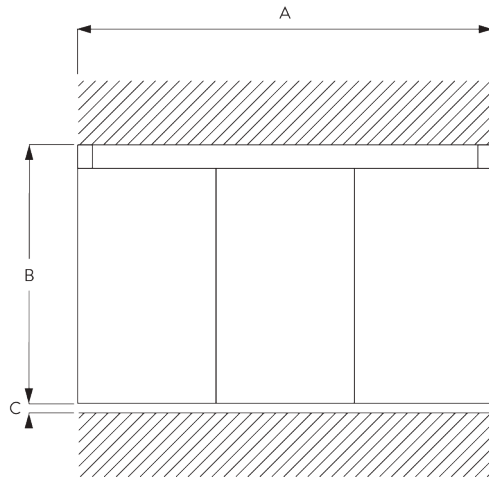

A: Systembreite
 B: Systemhöhe
 C: Abstand zwischen Boden und Behang

Paneele

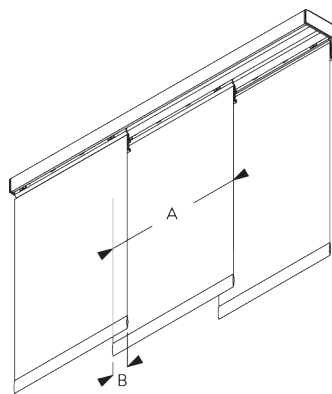

Frei verschiebbar:

A: Empfehlung Paneelbreite: 500 - 1200

Verbunden:

A: Empfehlung Paneelbreite: 500 - 1200

B: Überlappung: min. 50

MONTAGE

A. MONTAGE- INFORMATIONEN

Detaillierte Montageinformationen siehe
 Silent Gliss Website

Montagepunkte

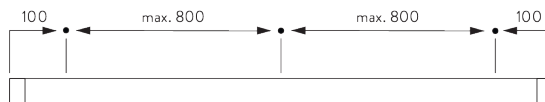

B. DECKEN- MONTAGE

Spanner SG 3003 /
 SG 3004

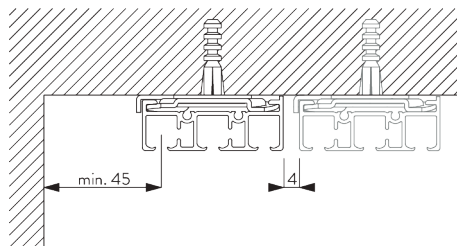

Spanner	SG 10122	SG 10123	SG 10124	SG 10125
SG 3004	X			
SG 3003		X	X	X

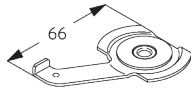

SG 3003
Spanner

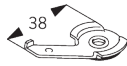

SG 3004
Spanner

Träger SG 10136 / SG 10137

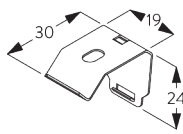
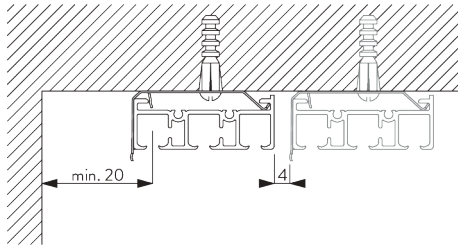

SG 10136
Träger

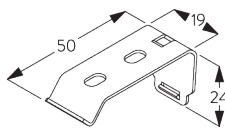

SG 10137
Träger

Träger	SG 10122	SG 10123	SG 10124
SG 10136	X		
SG 10137		X	X

C. WANDMONTAGE

Smart Fix

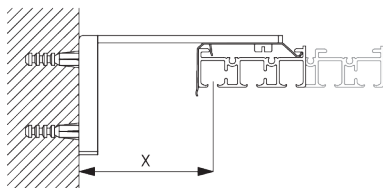

Smart Fix SG 11200 - SG 11204:
Träger SG 10136 für 2-läufiges Profil.
Träger SG 10137 für 3- bis 5-läufiges Profil.
Benötigt Schraube SG 10395 (M4x6).

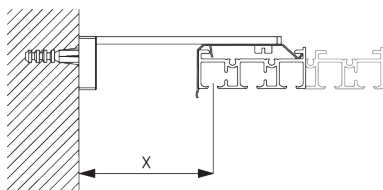

Square Smart Fix SG 11210 - SG 11214:
Träger SG 10136 für 2-läufiges Profil.
Träger SG 10137 für 3- bis 5-läufiges Profil.
Benötigt Schraube SG 10395 (M4x6).

Smart Fix	X mm (SG 10122)	X mm (SG 10123)	X mm (SG 10124)	X mm (SG 10125)
SG 11200 / SG 11210	43	24	24	24
SG 11201 / SG 11211	63	44	44	44
SG 11202 / SG 11212	83	64	64	64
SG 11203 / SG 11213	103	84	84	84
SG 11204 / SG 11214	133	114	114	114
SG 11154	93-121	74-102	74-102	74-102
SG 11155	123-151	104-132	104-132	104-132
SG 11156	172-201	154-182	154-182	154-182

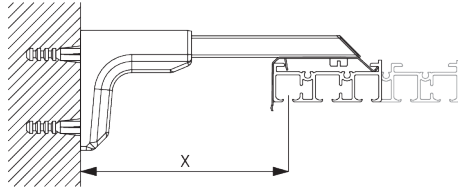

Universal Smart Fix SG 11154 - SG 11156:

Träger SG 10136 für 2-läufiges Profil.

Träger SG 10137 für 3- bis 5-läufiges Profil.

Benötigt Schraube SG 10492 (M4x8).

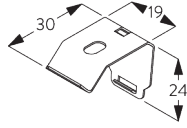

SG 10136

Träger

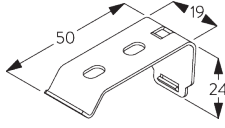

SG 10137

Träger



SG 10395

Linsenschraube M4x6



SG 10492

Linsenschraube M4x8

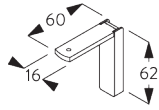

SG 11200

Smart Fix 60 mm

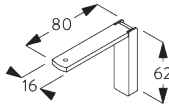

SG 11201

Smart Fix 80 mm

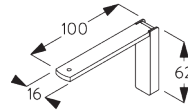

SG 11202

Smart Fix 100 mm

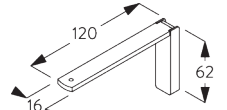

SG 11203

Smart Fix 120 mm

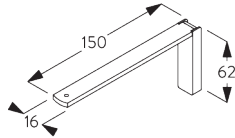

SG 11204

Smart Fix 150 mm

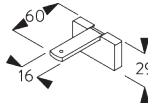

SG 11210

Square Smart Fix 60 mm

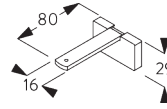

SG 11211

Square Smart Fix 80 mm

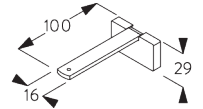

SG 11212

Square Smart Fix 100 mm

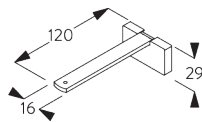

SG 11213

Square Smart Fix 120 mm

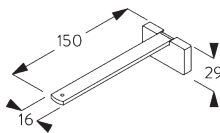

SG 11214

Square Smart Fix 150 mm

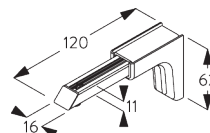

SG 11154

Universal Smart Fix 120 mm

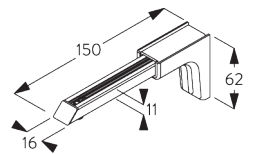

SG 11155

Universal Smart Fix 150 mm

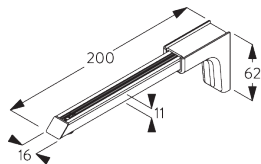

SG 11156

Universal Smart Fix 200 mm

D. NUTMONTAGE

Nutprofile SG 10172 - SG 10175

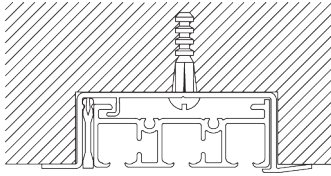

Eine Klammer SG 10157 pro Montagepunkt.

Detaillierte Nutmontage siehe Silent Gliss Website.

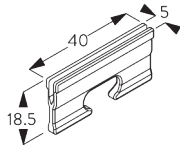

SG 10157

Klammer

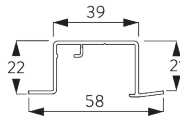

SG 10172

Nutprofil 2-läufig

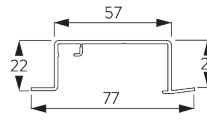

SG 10173

Nutprofil 3-läufig

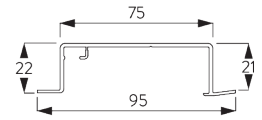

SG 10174

Nutprofil 4-läufig

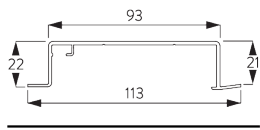

SG 10175

Nutprofil 5-läufig

SYSTEMOPTIONEN

A. BEDIENUNG

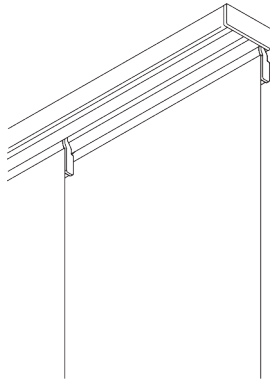

Frei verschiebbar (nicht verbundene Paneele)

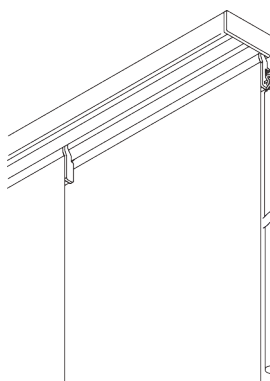

Verbundene Paneele (Schleuderstab optional)

B. PANEEL PAKET
(VERBUNDEN)



1-teiliges Paket

Bemerkung: Punkt = fixiertes Paneel









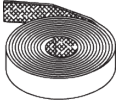

2-teiliges Paket

Bemerkung: Punkt = fixiertes Paneel

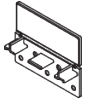

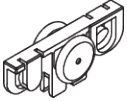







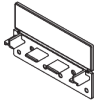

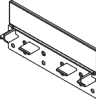

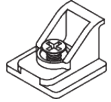

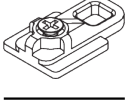

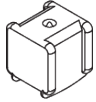
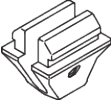
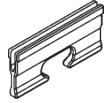
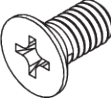

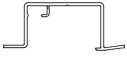
Andere Varianten sind möglich.

KOMPONENTEN

A. STANDARD KOMPONENTEN

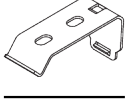
	SG 2005 Beschwerung 40x5 mm
	SG 2539 Flauschband
	SG 3003 Spanner
	SG 10123 Profil 3-läufig
	SG 10143 Enddeckel 3-läufig
	SG 10159 Senkschraube 3.5x13
	SG 10200 2C-Roller
	SG 10230 Panelwagen alu
	SG 10252 Enddeckel links
	SG 10253 Enddeckel rechts

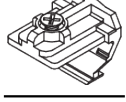
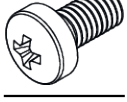
B. OPTIONALE KOMPONENTEN

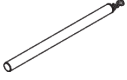
	SG 2004 Beschwerung 20x7 mm		SG 10144 Enddeckel 4-läufig
	SG 3004 Spanner		SG 10145 Enddeckel 5-läufig
	SG 3008 Profilverbinder		SG 10146 Mitnehmerwinkel
	SG 6024 Profilverbinder		SG 10148 Öse für Schleuderstab
	SG 6149 Sicherheitsgleiter		SG 10156 Endstop mit Schraube
	SG 6245 Verschlussfeder		SG 10157 Klammer
	SG 10074 Senkschraube M4x8		SG 10158 Klickgleiter
	SG 10122 Profil 2-läufig		SG 10172 Nutprofil 2-läufig
	SG 10124 Profil 4-läufig		SG 10173 Nutprofil 3-läufig
	SG 10125 Profil 5-läufig		SG 10174 Nutprofil 4-läufig
	SG 10136 Träger		SG 10175 Nutprofil 5-läufig
	SG 10137 Träger		SG 10340 Öse für Schleuderstab
	SG 10140 Mitnehmerwinkel		SG 10395 Linsenschraube M4x6
	SG 10142 Enddeckel 2-läufig		SG 10430 Schleuderstab 50 cm

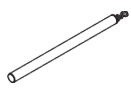

SG 10431

Schleuderstab 75 cm



SG 10432

Schleuderstab 100 cm

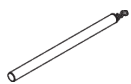

SG 10433

Schleuderstab 125 cm

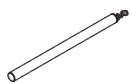

SG 10434

Schleuderstab 150 cm

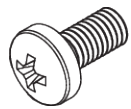

SG 10492

Linsenschraube M4x8

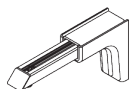

SG 11154

Universal Smart Fix 120 mm

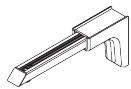

SG 11155

Universal Smart Fix 150 mm

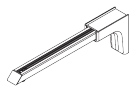

SG 11156

Universal Smart Fix 200 mm

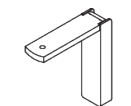

SG 11200

Smart Fix 60 mm

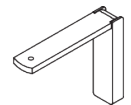

SG 11201

Smart Fix 80 mm

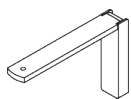

SG 11202

Smart Fix 100 mm

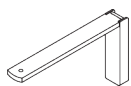

SG 11203

Smart Fix 120 mm



SG 11204

Smart Fix 150 mm

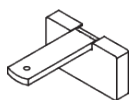

SG 11210

Square Smart Fix 60 mm

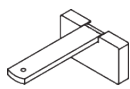

SG 11211

Square Smart Fix 80 mm

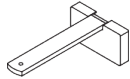

SG 11212

Square Smart Fix 100 mm

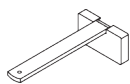

SG 11213

Square Smart Fix 120 mm

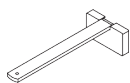

SG 11214

Square Smart Fix 150 mm

