

# METROPOLE

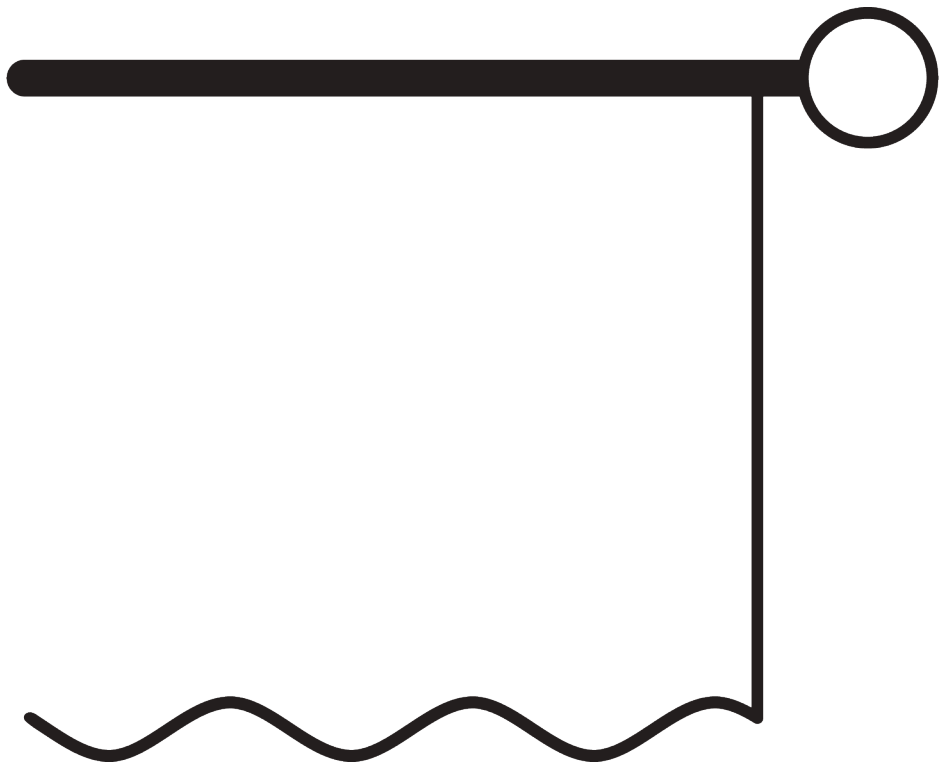

# ALLGEMEINE HINWEISE

## **Masse / Gewicht**

- Massangaben in mm ausser anderweitig angegeben.
- Max. kg bezieht sich auf Stoff inklusive Zubehör.
- Paketbreite hängt von Konfektionsart und Stoffbeschaffenheit ab.
- Gleiterabstand max. 80 mm / Rollerabstand max. 100 mm.
- Empfohlener Abstand Boden / Behang: 20 mm.
- Um Systemhöhe (B) zu bestimmen muss kleinste Raumhöhe berücksichtigt werden.













## **Montage**

- Montage nur durch Fachpersonal.
- Anzahl Träger und Montage- / Trägerpositionen sind abhängig von Montageuntergrund, Systemgewicht, Stoffkonfektion, Schrauben- / Dübeltyp sowie möglicher Hindernisse.
- Fachpersonal hat der Situation angemessene Schrauben / Dübel zu verwenden.
- Höhere Profilseite (falls vorhanden) raumseitig montieren.

## **Kindersicherung**

- Alle relevanten Silent Gliss Systeme entsprechen der Norm EN 13120.
- Norm EN 13120 muss von allen involvierten Parteien eingehalten werden.

# PRODUKTGRUPPEN-ÜBERSICHT

<u>SEITE</u>	<u>SYSTEM</u>	<u>BEDIENUNG</u>	<u>ABMESSUNGEN</u>	<u>DESIGN</u>	<u>WAVE</u>
5	<b>SG 7600</b>		S		
15	<b>SG 7605</b>		S - M		
25	<b>SG 7610</b>		S - M		
35	<b>SG 7620</b>		M - L		



# SG 7600

---

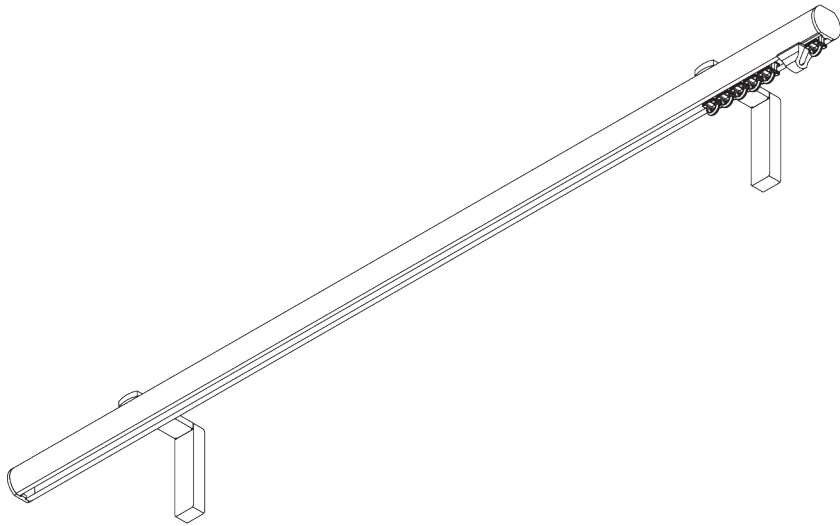
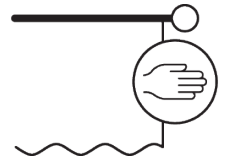

## PRODUKTINFORMATIONEN

- **Bedienung:** Hand
- **Grösse:** S
- **Montage:** Decke, Wand
- **Farben:** weiss RAL 9016, verschiedene Farben / Ausführungen
- **Stoffe:** siehe Silent Gliss Stoffkollektion

### **Merkmale:**

- 2-Komponenten-Gleiter-Technologie (2C)
- Wave (2C)
- Passende Enddeckel und Träger / Trägerabdeckungen
- Auswahl an dekorativen Endstücken
- Biegbar

# SYSTEMSPEZIFIKATIONEN

## A. PROFIL

Profil- und  
Biegeinformationen

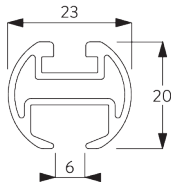

**SG 11606**

Profil

✓ Radius:  
15 cm, 20 cm, >25 cm

## B. MASSAUFNAHME

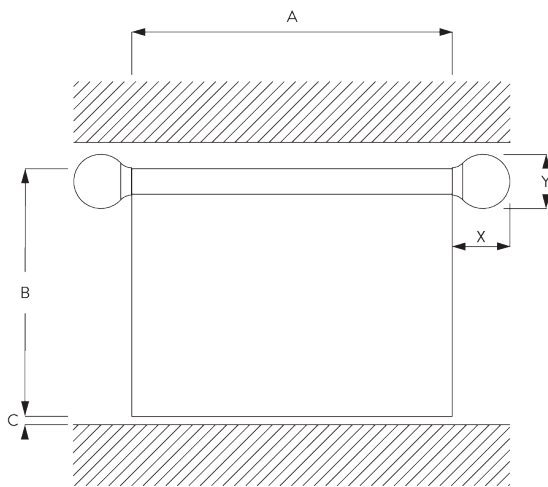

A: Systembreite ohne Endstücke







B: Systemhöhe

C: Abstand zwischen Boden und Behang

X: Endstückbreite

Y: Endstückhöhe

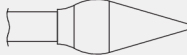
## Endstückmasse

		23 mm	
		X	Y
	SG 11602	2	23
	SG 11621	8	27
	SG 11622	14	38
	SG 11726	49	46
	SG 11727	89	37
	SG 11728	20	69
	SG 11729	18	46

# MONTAGE

## A. MONTAGE- INFORMATIONEN

Detaillierte Montageinformationen siehe  
Silent Gliss Website

### Montagepunkte

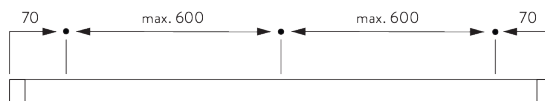

## B. DECKEN- MONTAGE

### Top Fix Träger SG 11668

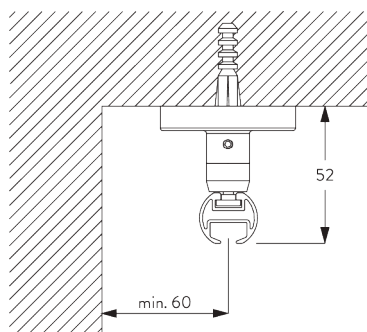

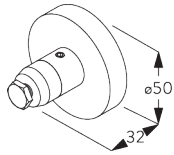

**SG 11668**

Top Fix Träger

### Mini Hänger SG 6175

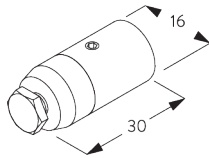
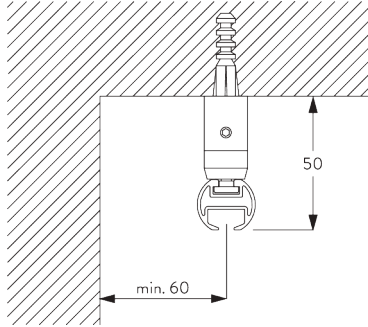

**SG 6175**

Mini Hänger

## C. WANDMONTAGE

### Smart Fix

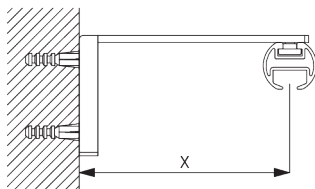

**Smart Fix mit Langloch SG 11206 - SG 11208 und SG 6141:**

Benötigt Schraube SG 10492 (M4x8).

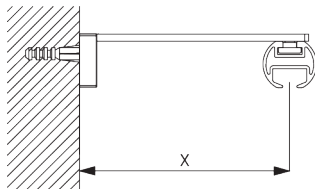

**Square Smart Fix mit Langloch SG 11216 - SG 11218 und SG 6141:**

Benötigt Schraube SG 10492 (M4x8).

Smart Fix	X mm	Y mm	Z mm
SG 11206 / SG 11216	51		
SG 11207 / SG 11217	71		
SG 11208 / SG 11218	91		
SG 11154	102-130		
SG 11155	132-160	68	65-72
SG 11156	182-210	68	65-123



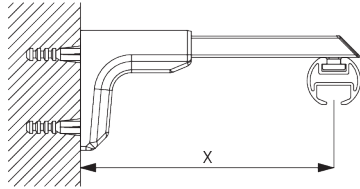

**Universal Smart Fix SG 11154 - SG 11156 und SG 6141:**  
Benötigt Schraube SG 11131 (M4x6).

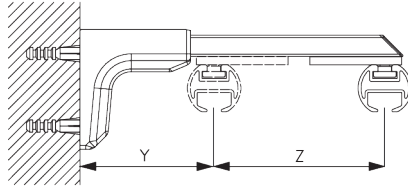

**Zwei Systeme:**  
**Universal Smart Fix SG 11155 - SG 11156 und SG 6151:**  
Benötigt Schraube SG 11127 (M4x10) und Mutter SG 11148.

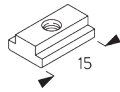

**SG 6141**  
Klemmstück

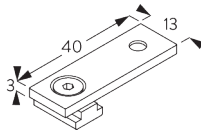

**SG 6151**  
Deckenträgerset 3 mm



**SG 10492**  
Linsenschraube M4x8



**SG 11127**  
Senkkopfschraube M4x10



**SG 11131**  
Linsenschraube mit Flansch  
M4x6



**SG 11148**  
Mutter

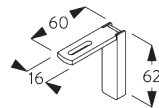

**SG 11206**  
Smart Fix 60 mm mit  
Langloch

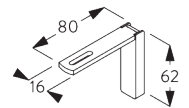

**SG 11207**  
Smart Fix 80 mm mit  
Langloch

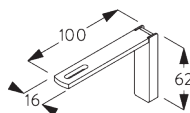

**SG 11208**  
Smart Fix 100 mm mit  
Langloch

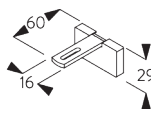

**SG 11216**  
Square Smart Fix 60 mm mit  
Langloch

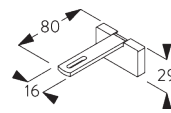

**SG 11217**  
Square Smart Fix 80 mm mit  
Langloch

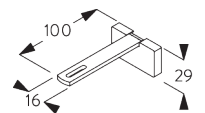

**SG 11218**  
Square Smart Fix 100 mm mit  
Langloch

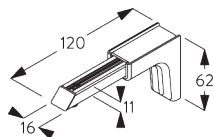

**SG 11154**  
Universal Smart Fix 120 mm

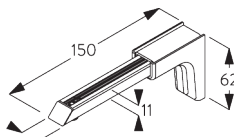

**SG 11155**  
Universal Smart Fix 150 mm

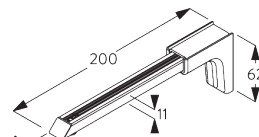

**SG 11156**  
Universal Smart Fix 200 mm

## Designträger SG 11669

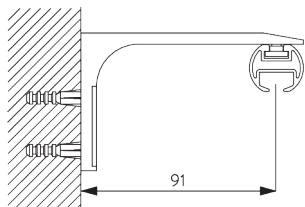

Benötigt Schraube SG 10492 (M4x8).  
Nur für gerade Systeme empfohlen.

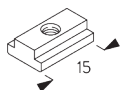

**SG 6141**  
Klemmstück



**SG 10492**  
Linsenschraube M4x8

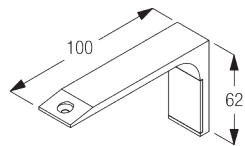

**SG 11669**  
Designträger

# DESIGN- & SYSTEMOPTIONEN

## A. ENDDECKEL



SG 11602



SG 11621



SG 11622

Enddeckel:

- SG 11602 Enddeckel bündig 23 mm
- SG 11621 Enddeckel Classic 23 mm
- SG 11622 Enddeckel Design 23 mm

Bemerkung:

- Ohne Endstücke werden die Systeme standardmäßig mit bündigen Enddeckel SG 11602 (links) geliefert.
- Alternativ können die Enddeckel Classic SG 11621 gewählt werden.

## B. ENDSTÜCKE



SG 11726

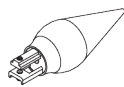

SG 11727



SG 11728



SG 11729

Endstücke sind dekorative Elemente, die am Ende des Profils angebracht werden:

- SG 11726 Kugel 23 mm
- SG 11727 Speer 23 mm
- SG 11728 Ellipse 23 mm
- SG 11729 Kegel 23 mm

## C. WAVE

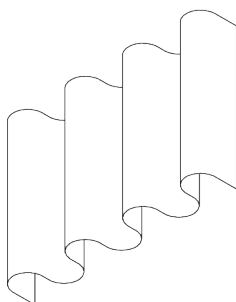

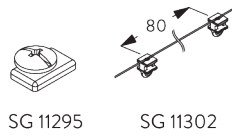

SG 11295

SG 11302

Standard Komponenten:

- SG 11295 Feststeller
- SG 11302 Wave-2C-Gleiterkordel 80 mm

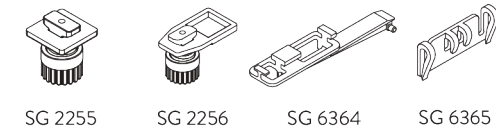

SG 2255

SG 2256

SG 6364

SG 6365

Optionale Komponenten (min. Radius >25 cm):

- SG 2255 Bremse
- SG 2256 Bremse
- SG 6364 Wave Verlängerung
- SG 6365 Wave Hänger
- SG 6366 Wave Träger für Schleuderstab
- SG 10430-34 Schleuderstab
- SG 11303 Wave-2C-Gleiterkordel 60 mm



SG 6366

SG 10430-34

SG 11303

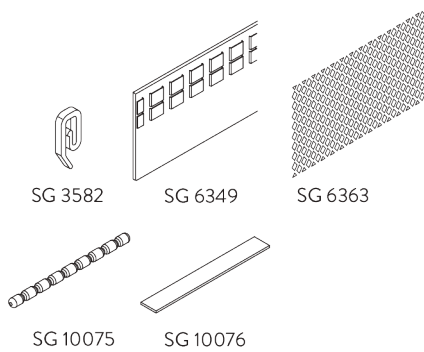

SG 3582

SG 6349

SG 6363

SG 10075

SG 10076

Vorhang Komponenten:

- SG 3582 Haken
- SG 6349 Wave Vorhangband
- SG 6363 Wave Bügelband
- SG 10075 Bleischnur 50 gr/m
- SG 10076 Beschwerung Seitensaum

Wave Paketbreite - 2C-Gleiterkordel (Standard Komponenten)

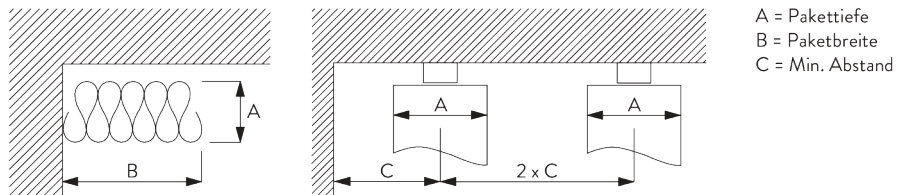

A = Pakettiefe  
B = Paketbreite  
C = Min. Abstand

2C-Gleiterkordel SG 11302	Zwischenlaschen	Stoffzugabe	Pakettiefe A	Paketbreite B*	Min. Abstand C
80	6	~2.1	140	180 pro Meter System	90
80	7	~2.3	160	180 pro Meter System	100

2C-Gleiterkordel SG 11303	Zwischenlaschen	Stoffzugabe	Pakettiefe A	Paketbreite B*	Min. Abstand C
60	4	~2.1	100	230 pro Meter System	70
60	5	~2.3	120	230 pro Meter System	80

\*Paketgröße B vergrößert sich um 95 mm pro Vorhangpaket bei Verwendung des optionalen Verlängerungsarms SG 6364!

# KOMPONENTEN

## A. STANDARD KOMPONENTEN



**SG 6065**

Feststeller



**SG 6141**

Klemmstück

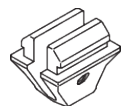

**SG 6245**

Verschlussfeder



**SG 10492**

Linsenschraube M4x8

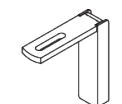

**SG 11206**

Smart Fix 60 mm mit Langloch

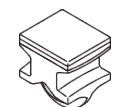

**SG 11305**

2C-Gleiter für direktes Annähen

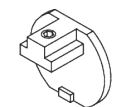

**SG 11602**

Enddeckel bündig 23 mm



**SG 11606**

Profil

## B. OPTIONALE KOMPONENTEN

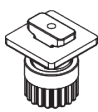

**SG 2255**

Bremse



**SG 2256**

Bremse



**SG 3012**

Haken



**SG 3582**

Haken



**SG 3599**

Haken



**SG 6057**

Gleiter



**SG 6082**

Gleiter

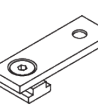

**SG 6151**

Deckenträger 3 mm



**SG 6173**

Verbinder

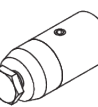

**SG 6175**

Mini Hänger



**SG 6349**

Wave Vorhangband

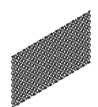

**SG 6363**

Wave Bügelband



**SG 6364**

Wave Verlängerungsarm

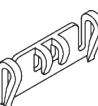

**SG 6365**

Wave Hänger

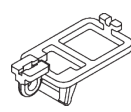

**SG 6366**

Wave Mitnehmer für Schleuderstab

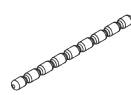

**SG 10075**

Bleischnur 50 gr/m

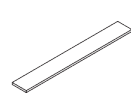

**SG 10076**

Beschwerung Seitensaum

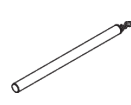

**SG 10430**

Schleuderstab 50 cm

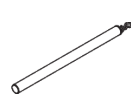

**SG 10431**

Schleuderstab 75 cm

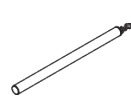

**SG 10432**

Schleuderstab 100 cm

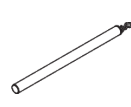

**SG 10433**

Schleuderstab 125 cm

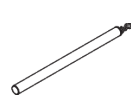

**SG 10434**

Schleuderstab 150 cm

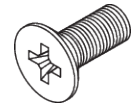

**SG 11127**

Senkkopfschraube M4x10

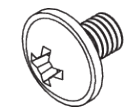

**SG 11131**

Linsenschraube mit Flansch M4x6

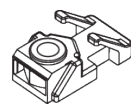

**SG 11148**

Mutter

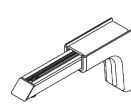

**SG 11154**

Universal Smart Fix 120 mm

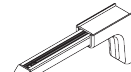

**SG 11155**

Universal Smart Fix 150 mm

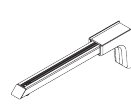

**SG 11156**

Universal Smart Fix 200 mm

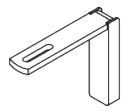
**SG 11207**

Smart Fix 80 mm mit Langloch

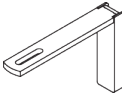
**SG 11208**

Smart Fix 100 mm mit Langloch

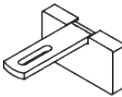
**SG 11216**

Square Smart Fix 60 mm mit Langloch

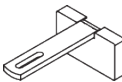
**SG 11217**

Square Smart Fix 80 mm mit Langloch

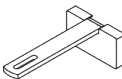
**SG 11218**

Square Smart Fix 100 mm mit Langloch

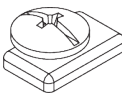
**SG 11295**

Feststeller

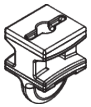
**SG 11300**

2C-Gleiter

**SG 11301**

2C-Gleiter am Strip

**SG 11302**

Wave-2C-Gleiterkordel 80 mm

**SG 11303**

Wave-2C-Gleiterkordel 60 mm

**SG 11621**

Enddeckel Classic 23 mm

**SG 11622**

Enddeckel Design 23 mm

**SG 11668**

Top Fix Träger

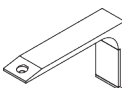
**SG 11669**

Designträger

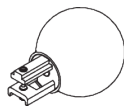
**SG 11726**

Kugel 23 mm

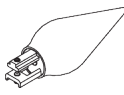
**SG 11727**

Speer 23 mm

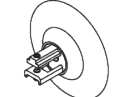
**SG 11728**

Ellipse 23 mm

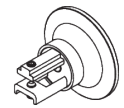
**SG 11729**

Kegel 23 mm



# SG 7605

---

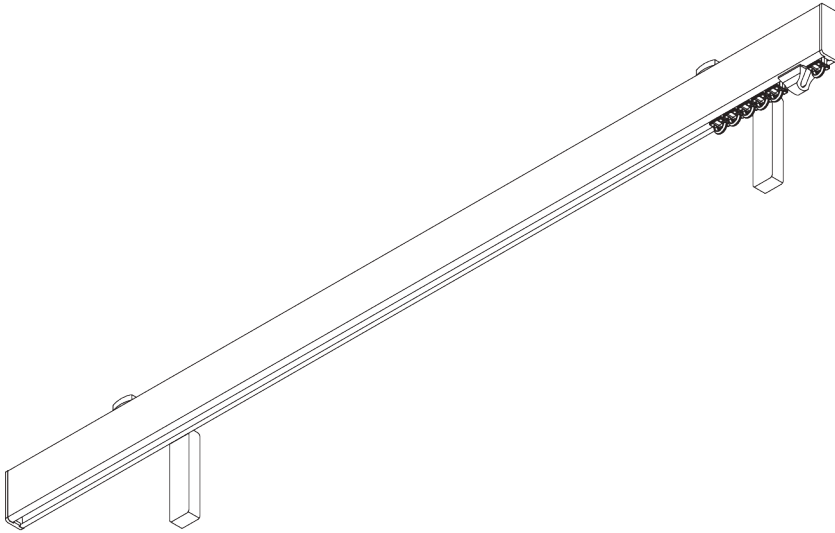
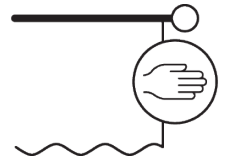

## PRODUKTINFORMATIONEN

- **Bedienung:** Hand
- **Grösse:** S - M
- **Montage:** Decke, Wand
- **Farben:** weiss RAL 9016, verschiedene Farben / Ausführungen
- **Stoffe:** siehe Silent Gliss Stoffkollektion

### **Merkmale:**

- 2-Komponenten-Gleiter-Technologie (2C)
- Wave (2C)
- Passende Enddeckel und Träger / Trägerabdeckungen
- Biegbar

# SYSTEMSPEZIFIKATIONEN

## A. PROFIL

Profil- und  
Biegeinformationen

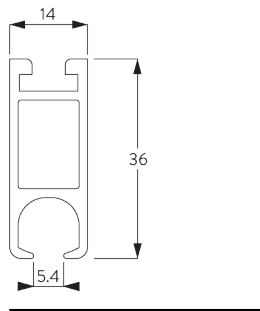

**SG 6101**

Profil

Radius:  
20 cm, >25 cm

## B. MASSAUFNAHME

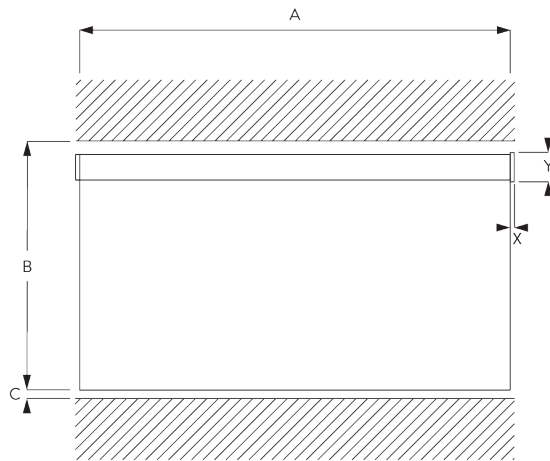

A: Systembreite ohne Enddeckel

B: Systemhöhe

C: Abstand zwischen Boden und Behang

X: Enddeckelbreite

Y: Enddeckelhöhe

## Enddeckelmasse

		36 mm	
		X	Y
	SG 11601	2	36
	SG 11611	5	40



# MONTAGE

## A. MONTAGE- INFORMATIONEN

Detaillierte Montageinformationen siehe  
Silent Gliss Website

### Montagepunkte

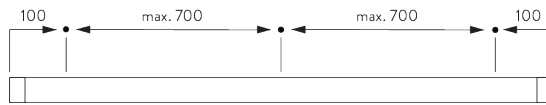

## B. DECKEN- MONTAGE

### Top Fix Träger SG 11668

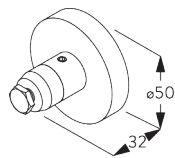
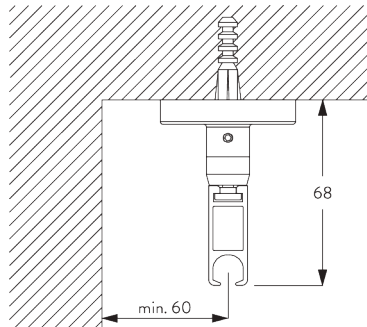

**SG 11668**  
Top Fix Träger

### Mini Hänger SG 6175

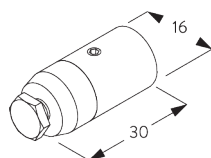
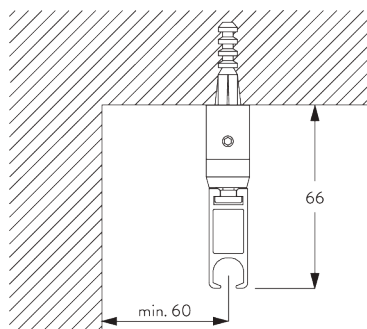

**SG 6175**  
Mini Hänger

## C. WANDMONTAGE

### Smart Fix

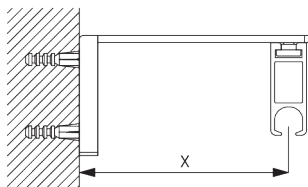

**Smart Fix mit Langloch SG 11206 - SG 11208 und SG 6141:**

Benötigt Schraube SG 10492 (M4x8).

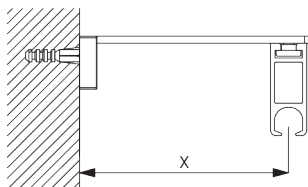

**Square Smart Fix mit Langloch SG 11216 - SG 11218 und SG 6141:**

Benötigt Schraube SG 10492 (M4x8).

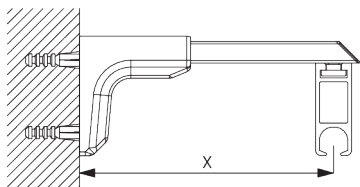

**Universal Smart Fix SG 11154 - SG 11156 und SG 6141:**

Benötigt Schraube SG 11131 (M4x6).

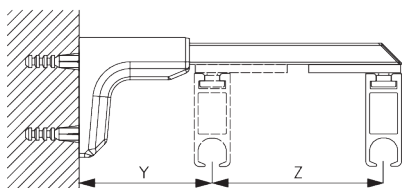

**Zwei Systeme:**

**Universal Smart Fix SG 11155 - SG 11156 und SG 6151:**

Benötigt Schraube SG 11127 (M4x10) und Mutter SG 11148.

Smart Fix	X mm	Y mm	Z mm
SG 11206 / SG 11216	51		
SG 11207 / SG 11217	71		
SG 11208 / SG 11218	91		
SG 11154	102-130		
SG 11155	132-160	68	65-72
SG 11156	182-210	68	65-123

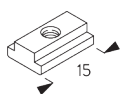

**SG 6141**  
Klemmstück

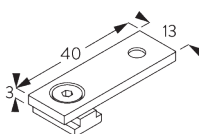

**SG 6151**  
Deckenträger set 3 mm



**SG 10492**  
Linsenschraube M4x8



**SG 11127**  
Senkkopfschraube M4x10



**SG 11131**  
Linsenschraube mit Flansch  
M4x6



**SG 11148**  
Mutter

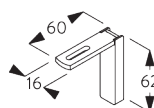

**SG 11206**  
Smart Fix 60 mm mit  
Langloch

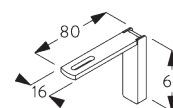

**SG 11207**  
Smart Fix 80 mm mit  
Langloch

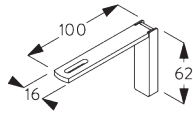

**SG 11208**

Smart Fix 100 mm mit Langloch

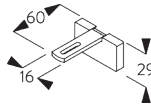

**SG 11216**

Square Smart Fix 60 mm mit Langloch

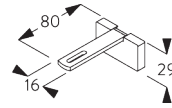

**SG 11217**

Square Smart Fix 80 mm mit Langloch

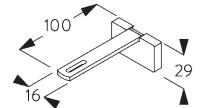

**SG 11218**

Square Smart Fix 100 mm mit Langloch

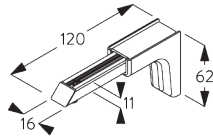

**SG 11154**

Universal Smart Fix 120 mm

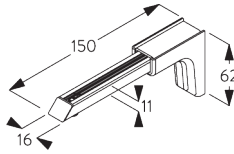

**SG 11155**

Universal Smart Fix 150 mm

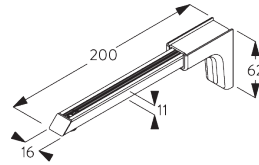

**SG 11156**

Universal Smart Fix 200 mm

## Designträger SG 11669

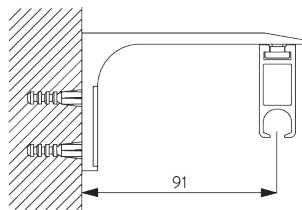

Benötigt Schraube SG 10492 (M4x8).  
Nur für gerade Systeme empfohlen.

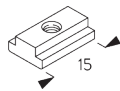

**SG 6141**

Klemmstück



**SG 10492**

Linsenschraube M4x8

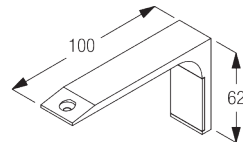

**SG 11669**

Designträger

# DESIGN- & SYSTEMOPTIONEN

## A. ENDDECKEL



SG 11601



SG 11611

Bemerkung:

- Die Systeme werden standardmäßig mit bündigen Enddeckel SG 11601 (links) geliefert.
- Alternativ können die Enddeckel Classic SG 11611 (rechts) gewählt werden.

## B. WAVE

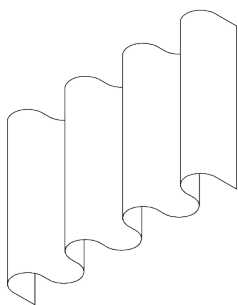

SG 11295

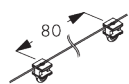

SG 11302

### Standard Komponenten:

- SG 11295 Feststeller
- SG 11302 Wave-2C-Gleiterkordel 80 mm



SG 2255



SG 2256

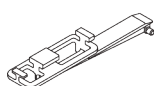

SG 6364



SG 6365

### Optionale Komponenten (min. Radius >25 cm):

- SG 2255 Bremse
- SG 2256 Bremse
- SG 6364 Wave Verlängerung
- SG 6365 Wave Hänger
- SG 6366 Wave Träger für Schleuderstab
- SG 10430-34 Schleuderstab
- SG 11303 Wave-2C-Gleiterkordel 60 mm

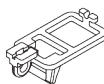

SG 6366



SG 10430-34

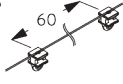

SG 11303



SG 3582

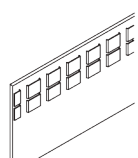

SG 6349

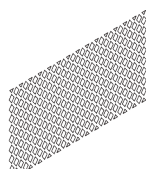

SG 6363

### Vorhang Komponenten:

- SG 3582 Haken
- SG 6349 Wave Vorhangband
- SG 6363 Wave Bügelband
- SG 10075 Bleischnur 50 gr/m
- SG 10076 Beschwerung Seitensaum

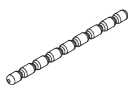

SG 10075



SG 10076

Wave Paketbreite - 2C-Gleiterkordel (Standard Komponenten)

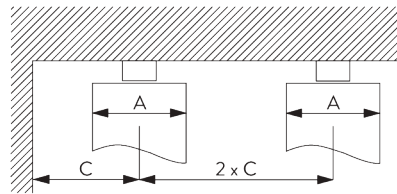
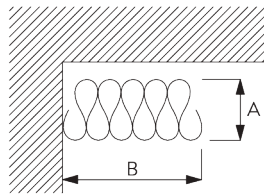

A = Pakettiefe  
B = Paketbreite  
C = Min. Abstand

2C-Gleiterkordel SG 11302	Zwischen- laschen	Stoffzugabe	Pakettiefe A	Paketbreite B*	Min. Abstand C
80	6	~2.1	140	180 pro Meter System	90
80	7	~2.3	160	180 pro Meter System	100

2C-Gleiterkordel SG 11303	Zwischen- laschen	Stoffzugabe	Pakettiefe A	Paketbreite B*	Min. Abstand C
60	4	~2.1	100	230 pro Meter System	70
60	5	~2.3	120	230 pro Meter System	80

\*Paketgröße B vergrößert sich um 95 mm pro Vorhangpaket bei Verwendung des optionalen Verlängerungsarms SG 6364!

# KOMPONENTEN

## A. STANDARD KOMPONENTEN



**SG 6065**

Feststeller

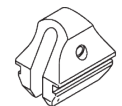

**SG 6086**

Verschlussfeder

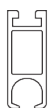

**SG 6101**

Profil

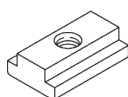

**SG 6141**

Klemmstück



**SG 10492**

Linsenschraube M4x8

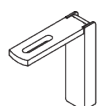

**SG 11206**

Smart Fix 60 mm mit Langloch



**SG 11305**

2C-Gleiter für direktes Annähen

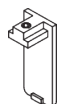

**SG 11601**

Enddeckel bündig 36 mm

## B. OPTIONALE KOMPONENTEN

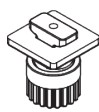

**SG 2255**

Bremse

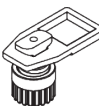

**SG 2256**

Bremse



**SG 3012**

Haken



**SG 3582**

Haken



**SG 3599**

Haken



**SG 6053**

Verschlussfeder



**SG 6057**

Gleiter



**SG 6082**

Gleiter



**SG 6094**

Roller



**SG 6098**

Roller



**SG 6112**

Profilverbinder

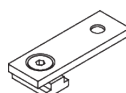

**SG 6151**

Deckenträger set 3 mm

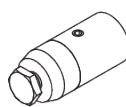

**SG 6175**

Mini Hänger



**SG 6283**

Roller

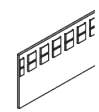

**SG 6349**

Wave Vorhangband

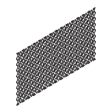

**SG 6363**

Wave Bügelband

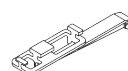

**SG 6364**

Wave Verlängerungsarm



**SG 6365**

Wave Hänger

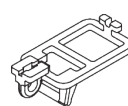

**SG 6366**

Wave Mitnehmer für Schleuderstab



**SG 10075**

Bleischnur 50 gr/m



**SG 10076**

Beschwerung Seitensaum

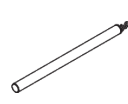

**SG 10430**

Schleuderstab 50 cm

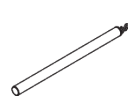

**SG 10431**

Schleuderstab 75 cm

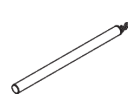

**SG 10432**

Schleuderstab 100 cm

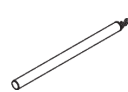

**SG 10433**

Schleuderstab 125 cm

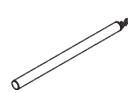

**SG 10434**

Schleuderstab 150 cm

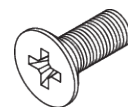

**SG 11127**

Senkkopfschraube M4x10

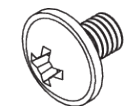

**SG 11131**

Linsenschraube mit Flansch M4x6

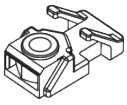

**SG 11148**

Mutter

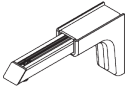

**SG 11154**

Universal Smart Fix 120 mm

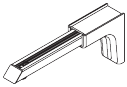

**SG 11155**

Universal Smart Fix 150 mm

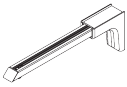

**SG 11156**

Universal Smart Fix 200 mm

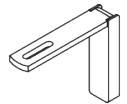

**SG 11207**

Smart Fix 80 mm mit Langloch

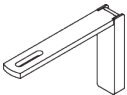

**SG 11208**

Smart Fix 100 mm mit Langloch

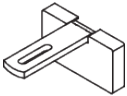

**SG 11216**

Square Smart Fix 60 mm mit Langloch

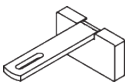

**SG 11217**

Square Smart Fix 80 mm mit Langloch

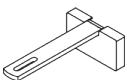

**SG 11218**

Square Smart Fix 100 mm mit Langloch

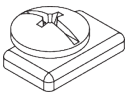

**SG 11295**

Feststeller

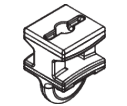

**SG 11300**

2C-Gleiter



**SG 11301**

2C-Gleiter am Strip

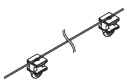

**SG 11302**

Wave-2C-Gleiterkordel 80 mm

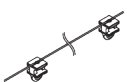

**SG 11303**

Wave-2C-Gleiterkordel 60 mm

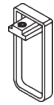

**SG 11611**

Enddeckel Classic 36 mm



**SG 11668**

Top Fix Träger

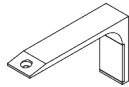

**SG 11669**

Designträger





# SG 7610

---

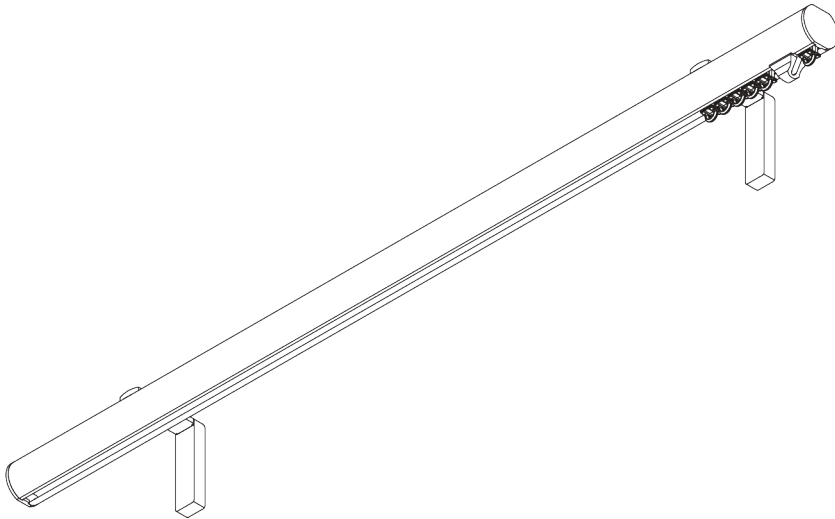
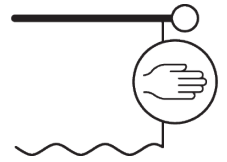

## PRODUCT INFORMATION

- **Bedienung:** Hand
- **Grösse:** S - M
- **Montage:** Decke, Wand
- **Farben:** weiss RAL 9016, verschiedene Farben / Ausführungen
- **Stoffe:** siehe Silent Gliss Stoffkollektion

### **Merkmale:**

- 2-Komponenten-Gleiter-Technologie (2C)
- Wave (2C)
- Passende Enddeckel und Träger / Trägerabdeckungen
- Auswahl an dekorativen Endstücken
- Biegsam

# SYSTEMSPEZIFIKATIONEN

## A. PROFIL

Profil- und  
Biegeinformationen

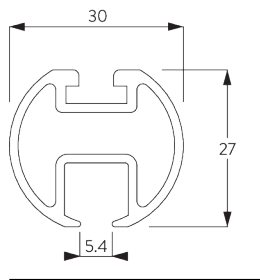

**SG 6103p**

Profil

✓ Radius:  
>25 cm

## B. MASSAUFNAHME

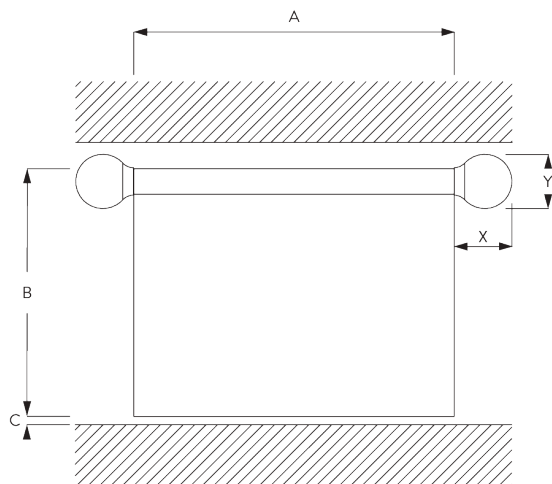

A: Systembreite ohne Endstücke







B: Systemhöhe

C: Abstand zwischen Boden und Behang

X: Endstückbreite

Y: Endstückhöhe

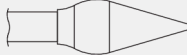
## Endstückmasse

		30 mm	
		X	Y
	SG 11603	2	30
	SG 11631	10	34
	SG 11632	18	50
	SG 11746	64	60
	SG 11747	116	48
	SG 11748	26	90
	SG 11749	20	60

# MONTAGE

## A. MONTAGE- INFORMATIONEN

*Detaillierte Montageinformationen siehe  
Silent Gliss Website*

### Montagepunkte

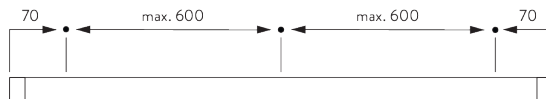

## B. DECKEN- MONTAGE

Top Fix Träger  
SG 11668

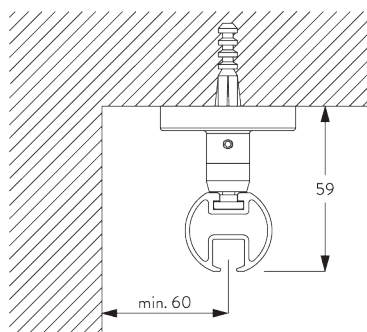



**SG 11668**

Top Fix Träger

## Mini Hänger SG 6175

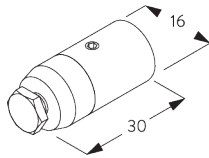
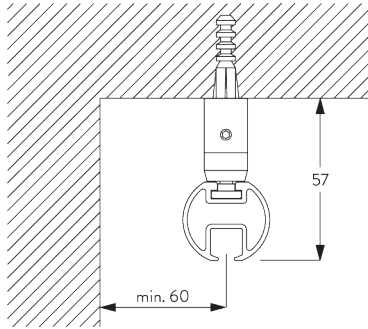

**SG 6175**

Mini Hänger

## C. WANDMONTAGE

### Smart Fix

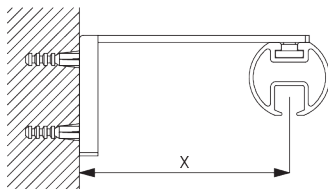

**Smart Fix mit Langloch SG 11206 - SG 11208 und SG 6141:**

Benötigt Schraube SG 10492 (M4x8).

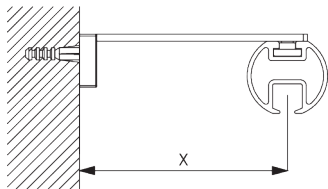

**Square Smart Fix mit Langloch SG 11216 - SG 11218 und SG 6141:**

Benötigt Schraube SG 10492 (M4x8).

Smart Fix	X mm	Y mm	Z mm
SG 11206 / SG 11216	51		
SG 11207 / SG 11217	71		
SG 11208 / SG 11218	91		
SG 11154	102-130		
SG 11155	132-160	68	65-72
SG 11156	182-210	68	65-123

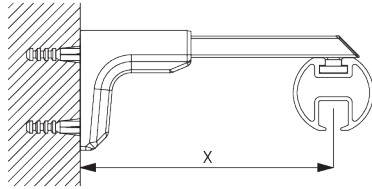

**Universal Smart Fix SG 11154 - SG 11156 und SG 6141:**  
Benötigt Schraube SG 11131 (M4x6).

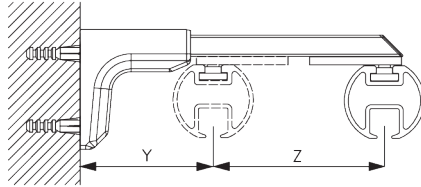

**Zwei Systeme:**  
**Universal Smart Fix SG 11155 - SG 11156 und SG 6151:**  
Benötigt Schraube SG 11127 (M4x10) und Mutter SG 11148.

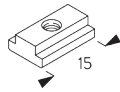

**SG 6141**  
Klemmstück

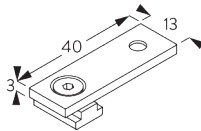

**SG 6151**  
Deckenträgerset 3 mm



**SG 10492**  
Linsenschraube M4x8



**SG 11127**  
Senkkopfschraube M4x10



**SG 11131**  
Linsenschraube mit Flansch  
M4x6



**SG 11148**  
Mutter

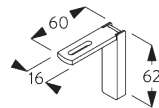

**SG 11206**  
Smart Fix 60 mm mit  
Langloch

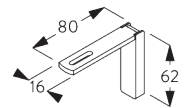

**SG 11207**  
Smart Fix 80 mm mit  
Langloch

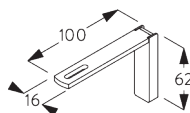

**SG 11208**  
Smart Fix 100 mm mit  
Langloch

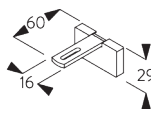

**SG 11216**  
Square Smart Fix 60 mm mit  
Langloch

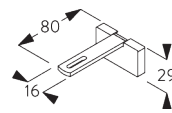

**SG 11217**  
Square Smart Fix 80 mm mit  
Langloch

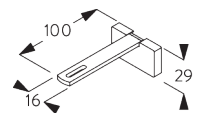

**SG 11218**  
Square Smart Fix 100 mm mit  
Langloch

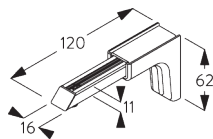

**SG 11154**  
Universal Smart Fix 120 mm

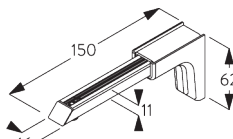

**SG 11155**  
Universal Smart Fix 150 mm

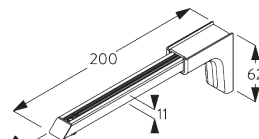

**SG 11156**  
Universal Smart Fix 200 mm

## Designträger SG 11669

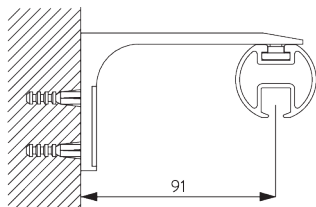

Benötigt Schraube SG 10492 (M4x8).  
Nur für gerade Systeme empfohlen.

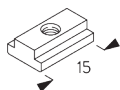

**SG 6141**  
Klemmstück



**SG 10492**  
Linsenschraube M4x8

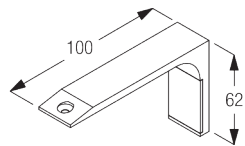

**SG 11669**  
Designträger

# DESIGN- & SYSTEMOPTIONEN

## A. ENDDECKEL



SG 11603



SG 11631



SG 11632

Enddeckel:

- SG 11603 Enddeckel bündig 30 mm
- SG 11631 Enddeckel Classic 30 mm
- SG 11632 Enddeckel Design 30 mm

Bemerkung:

- Ohne Endstücke werden die Systeme standardmäßig mit bündigen Enddeckel SG 11603 (links) geliefert.
- Alternativ können die Enddeckel Classic SG 11631 gewählt werden.

## B. ENDSTÜCKE



SG 11746



SG 11747



SG 11748



SG 11749

Endstücke sind dekorative Elemente, die am Ende des Profils angebracht werden:

- SG 11746 Kugel 30 mm
- SG 11747 Speer 30 mm
- SG 11748 Ellipse 30 mm
- SG 11749 Kegel 30 mm

## C. WAVE

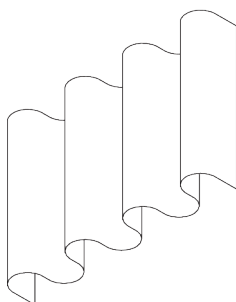

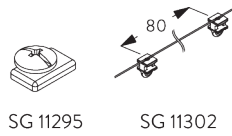

SG 11295

SG 11302

**Standard Komponenten:**

- SG 11295 Feststeller
- SG 11302 Wave-2C-Gleiterkordel 80 mm

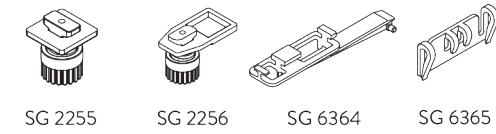

SG 2255

SG 2256

SG 6364

SG 6365

**Optionale Komponenten:**

- SG 2255 Bremse
- SG 2256 Bremse
- SG 6364 Wave Verlängerung
- SG 6365 Wave Hänger
- SG 6366 Wave Träger für Schleuderstab
- SG 10430-34 Schleuderstab
- SG 11303 Wave-2C-Gleiterkordel 60 mm



SG 6366

SG 10430-34

SG 11303

**Vorhang Komponenten:**

- SG 3582 Haken
- SG 6349 Wave Vorhangband
- SG 6363 Wave Bügelband
- SG 10075 Bleischnur 50 gr/m
- SG 10076 Beschwerung Seitensaum

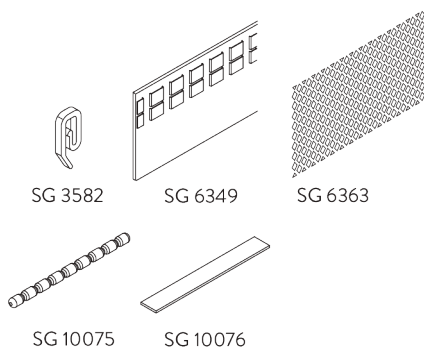

SG 3582

SG 6349

SG 6363

SG 10075

SG 10076

**Wave stack depth - 2C glider cord (standard components)**

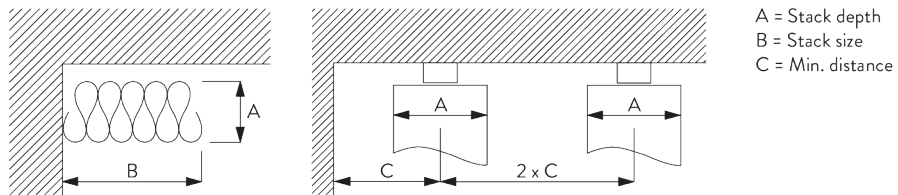

A = Stack depth  
B = Stack size  
C = Min. distance

2C Glider cord SG 11302	Pockets between hooks	Approx. curtain fullness	Stack depth A	Stack size B*	Min distance C
80	6	~2.1	140	180 per metre of track	90
80	7	~2.3	160	180 per metre of track	100

2C Glider cord SG 11303	Pockets between hooks	Approx. curtain fullness	Stack depth A	Stack size B*	Min distance C
60	4	~2.1	100	230 per metre of track	70
60	5	~2.3	120	230 per metre of track	80

\*Paketgröße B vergrößert sich um 95 mm pro Vorhangpaket bei Verwendung des optionalen Verlängerungsarms SG 6364!

# KOMPONENTEN

## A. STANDARD KOMPONENTEN



**SG 6065**

Feststeller

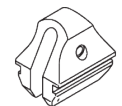

**SG 6086**

Verschlussfeder



**SG 6103p**

Profil

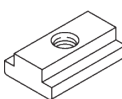

**SG 6141**

Klemmstück



**SG 10492**

Linsenschraube M4x8

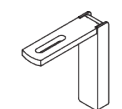

**SG 11206**

Smart Fix 60 mm mit Langloch



**SG 11305**

2C-Gleiter für direktes Annähen

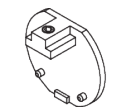

**SG 11603**

Enddeckel bündig 30 mm

## B. OPTIONALE KOMPONENTEN

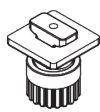

**SG 2255**

Bremse

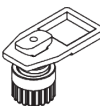

**SG 2256**

Bremse



**SG 3012**

Haken

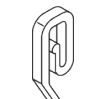

**SG 3582**

Haken



**SG 3599**

Haken



**SG 6057**

Gleiter

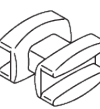

**SG 6082**

Gleiter



**SG 6094**

Roller



**SG 6098**

Roller

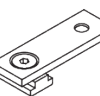

**SG 6151**

Deckenträgerset 3 mm

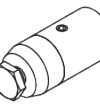

**SG 6175**

Mini Hänger



**SG 6283**

Roller



**SG 6349**

Wave Vorhangband



**SG 6363**

Wave Bügelband

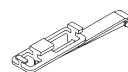

**SG 6364**

Wave Verlängerungsarm

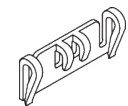

**SG 6365**

Wave Hänger

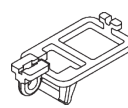

**SG 6366**

Wave Mitnehmer für Schleuderstab

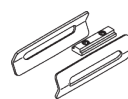

**SG 6635**

Verbindungsset



**SG 10075**

Bleischnur 50 gr/cm

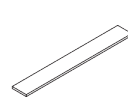

**SG 10076**

Beschwerung Seitensaum

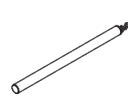

**SG 10430**

Schleuderstab 50 cm

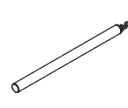

**SG 10431**

Schleuderstab 75 cm

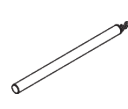

**SG 10432**

Schleuderstab 100 cm

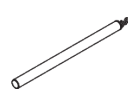

**SG 10433**

Schleuderstab 125 cm

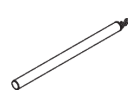

**SG 10434**

Schleuderstab 150 cm

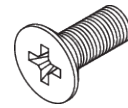

**SG 11127**

Senkkopfschraube M4x10

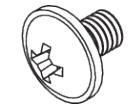

**SG 11131**

Linsenschraube mit Flansch M4x6

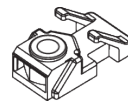

**SG 11148**

Mutter



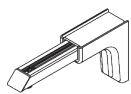

**SG 11154**  
Universal Smart Fix 120 mm

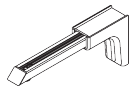

**SG 11155**  
Universal Smart Fix 150 mm

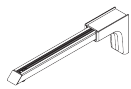

**SG 11156**  
Universal Smart Fix 200 mm

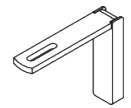

**SG 11207**  
Smart Fix 80 mm mit Langloch

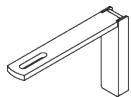

**SG 11208**  
Smart Fix 100 mm mit Langloch

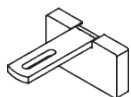

**SG 11216**  
Square Smart Fix 60 mm mit Langloch

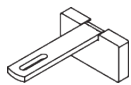

**SG 11217**  
Square Smart Fix 80 mm mit Langloch

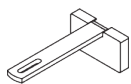

**SG 11218**  
Square Smart Fix 100 mm mit Langloch

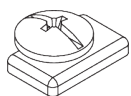

**SG 11295**  
Feststeller

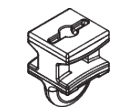

**SG 11300**  
2C-Gleiter



**SG 11301**  
2C-Gleiter am Strip

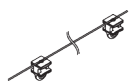

**SG 11302**  
Wave-2C-Gleiterkordel 80 mm

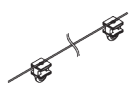

**SG 11303**  
Wave-2C-Gleiterkordel 60 mm

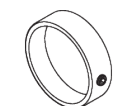

**SG 11631**  
Enddeckel Classic 30 mm



**SG 11632**  
Enddeckel Design 30 mm



**SG 11668**  
Top Fix Träger

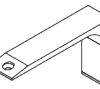

**SG 11669**  
Designträger

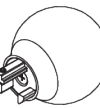

**SG 11746**  
Kugel 30 mm

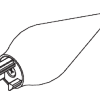

**SG 11747**  
Speer 30 mm



**SG 11748**  
Ellipse 30 mm



**SG 11749**  
Kegel 30 mm



# SG 7620

---

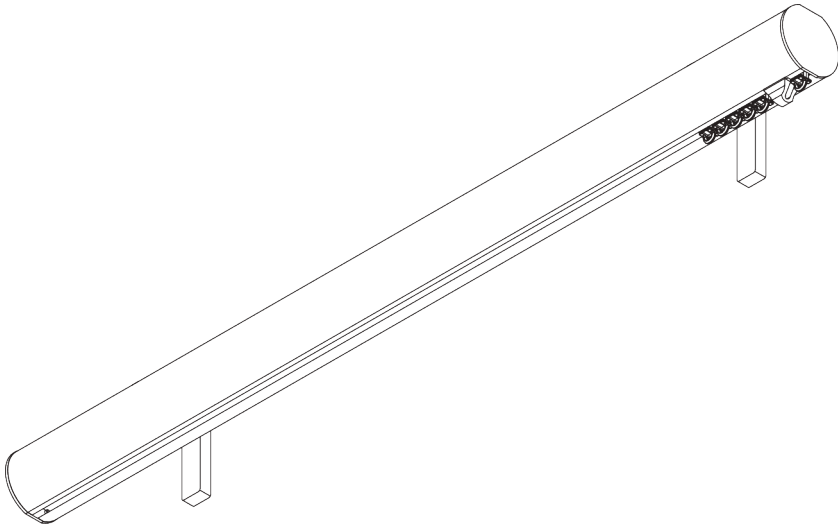
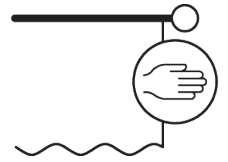

## PRODUKTINFORMATIONEN

- **Bedienung:** Hand
- **Grösse:** M - L
- **Montage:** Decke, Wand
- **Farben:** weiss RAL 9016, verschiedene Farben / Ausführungen
- **Stoffe:** siehe Silent Gliss Stoffkollektion

### **Merkmale:**

- 2-Komponenten-Gleiter-Technologie (2C)
- Wave (2C)
- Passende Enddeckel und Träger / Trägerabdeckungen
- Auswahl an dekorativen Endstücken
- Biegsam

# SYSTEMSPEZIFIKATIONEN

## A. PROFIL

Profil- und  
Biegeinformationen

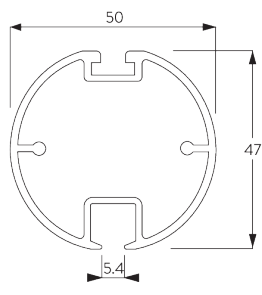

**SG 11609**

Profil

Radius:  
>50 cm

## B. MASSAUFNAHME

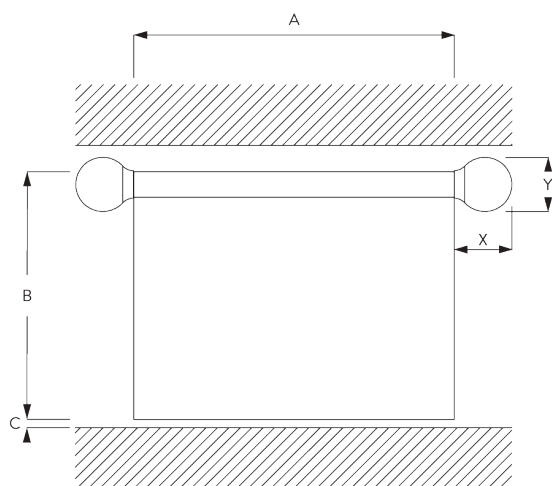

A: Systembreite ohne Endstücke







B: Systemhöhe

C: Abstand zwischen Boden und Behang

X: Endstückbreite

Y: Endstückhöhe

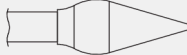
## Endstückmasse

		50 mm	
		X	Y
	SG 11605	2	51
	SG 11651	10	56
	SG 11652	24	75
	SG 11776	90	85
	SG 11777	165	70
	SG 11778	32	130
	SG 11779	30	100

# MONTAGE

## A. MONTAGE- INFORMATIONEN

*Detaillierte Montageinformationen siehe  
Silent Gliss Website*

### Montagepunkte

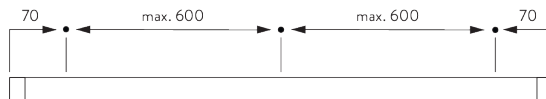

## B. DECKEN- MONTAGE

Top Fix Träger  
SG 11668

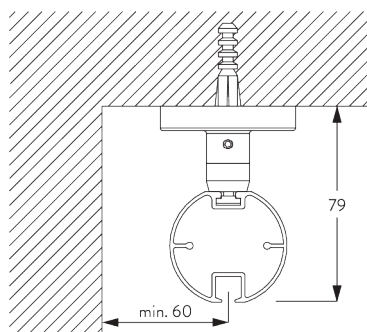

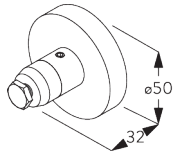

**SG 11668**

Top Fix Träger

### Mini Hänger SG 6175

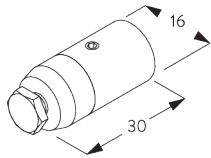
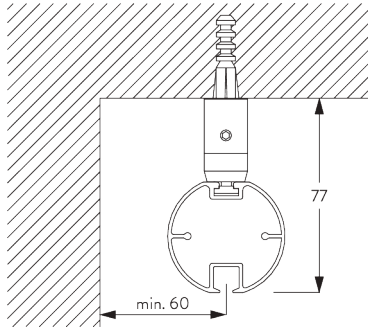

**SG 6175**

Mini Hänger

## C. WANDMONTAGE

### Smart Fix

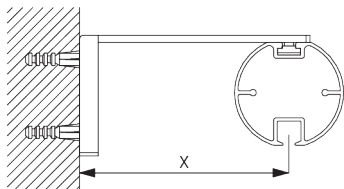

**Smart Fix mit Langloch SG 11206 - SG 11208 und SG 6141:**

Benötigt Schraube SG 10492 (M4x8).

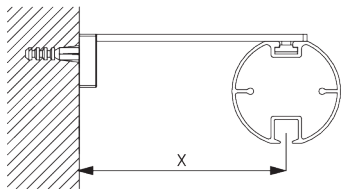

**Square Smart Fix mit Langloch SG 11216 - SG 11218 und SG 6141:**

Benötigt Schraube SG 10492 (M4x8).

Smart Fix	X mm	Y mm	Z mm
SG 11206 / SG 11216	51		
SG 11207 / SG 11217	71		
SG 11208 / SG 11218	91		
SG 11154	102-130		
SG 11155	132-160	68	65-72
SG 11156	182-210	68	65-123

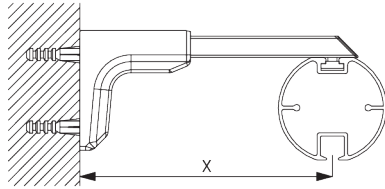

**Universal Smart Fix SG 11154 - SG 11156 und SG 6141:**  
Benötigt Schraube SG 11131 (M4x6).

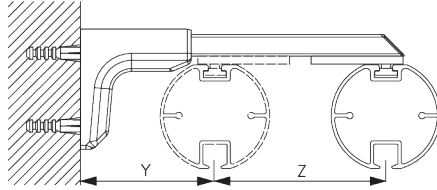

**Zwei Systeme:**  
**Universal Smart Fix SG 11155 - SG 11156 und SG 6151:**  
Benötigt Schraube SG 11127 (M4x10) und Mutter SG 11148.

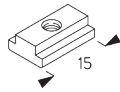

**SG 6141**  
Klemmstück

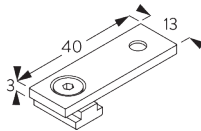

**SG 6151**  
Deckenträgerset 3 mm



**SG 10492**  
Linsenschraube M4x8



**SG 11127**  
Senkkopfschraube M4x10



**SG 11131**  
Linsenschraube mit Flansch  
M4x6



**SG 11148**  
Mutter

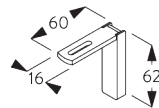

**SG 11206**  
Smart Fix 60 mm mit  
Langloch

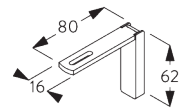

**SG 11207**  
Smart Fix 80 mm mit  
Langloch

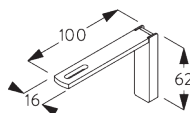

**SG 11208**  
Smart Fix 100 mm mit  
Langloch

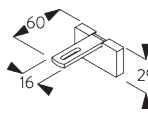

**SG 11216**  
Square Smart Fix 60 mm mit  
Langloch

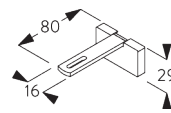

**SG 11217**  
Square Smart Fix 80 mm mit  
Langloch

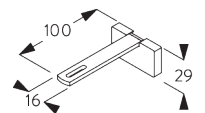

**SG 11218**  
Square Smart Fix 100 mm mit  
Langloch

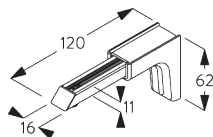

**SG 11154**  
Universal Smart Fix 120 mm

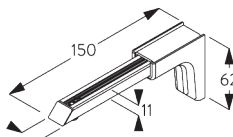

**SG 11155**  
Universal Smart Fix 150 mm

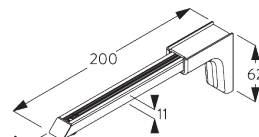

**SG 11156**  
Universal Smart Fix 200 mm

## Designträger SG 11669

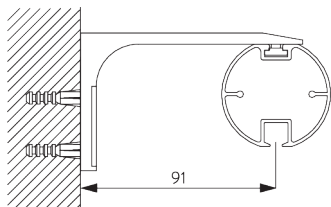

Benötigt Schraube SG 10492 (M4x8).  
Nur für gerade Systeme empfohlen.

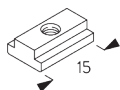

**SG 6141**  
Klemmstück



**SG 10492**  
Linsenschraube M4x8

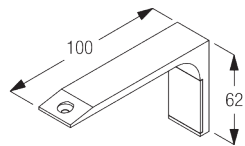

**SG 11669**  
Designträger

# DESIGN- & SYSTEMOPTIONEN

## A. ENDDECKEL



SG 11605



SG 11651



SG 11652

Enddeckel:

- SG 11605 Enddeckel bündig 50 mm
- SG 11651 Enddeckel Classic 50 mm
- SG 11652 Enddeckel Design 50 mm

Bemerkung:

- Ohne Endstücke werden die Systeme standardmäßig mit bündigen Enddeckel SG 11605 (links) geliefert.
- Alternativ können die Enddeckel Classic SG 11651 gewählt werden.

## B. ENDSTÜCKE



SG 11776

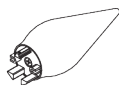

SG 11777



SG 11778



SG 11779

Endstücke sind dekorative Elemente, die am Ende des Profils angebracht werden:

- SG 11776 Kugel 50 mm
- SG 11777 Speer 50 mm
- SG 11778 Ellipse 50 mm
- SG 11779 Kegel 50 mm

## C. WAVE

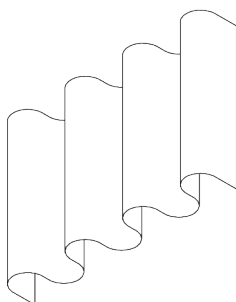



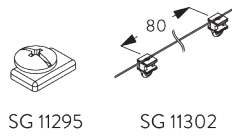

SG 11295

SG 11302

**Standard Komponenten:**

- SG 11295 Feststeller
- SG 11302 Wave-2C-Gleiterkordel 80 mm

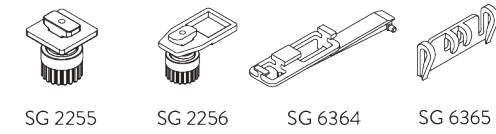

SG 2255

SG 2256

SG 6364

SG 6365

**Optionale Komponenten:**

- SG 2255 Bremse
- SG 2256 Bremse
- SG 6364 Wave Verlängerung
- SG 6365 Wave Hänger
- SG 6366 Wave Träger für Schleuderstab
- SG 10430-34 Schleuderstab
- SG 11303 Wave-2C-Gleiterkordel 60 mm

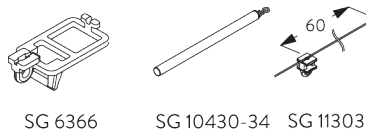

SG 6366

SG 10430-34

SG 11303

**Vorhang Komponenten:**

- SG 3582 Haken
- SG 6349 Wave Vorhangband
- SG 6363 Wave Bügelband
- SG 10075 Bleischnur 50 gr/m
- SG 10076 Beschwerung Seitensaum

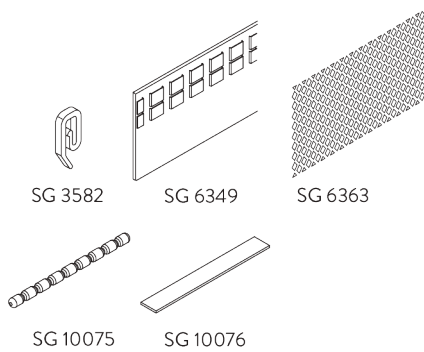

SG 3582

SG 6349

SG 6363

SG 10075

SG 10076

**Wave stack depth - 2C glider cord (standard components)**

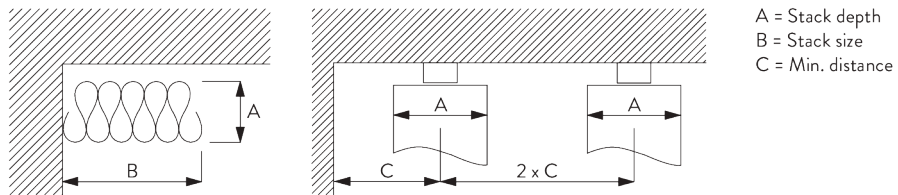

A = Stack depth  
B = Stack size  
C = Min. distance

2C Glider cord SG 11302	Pockets between hooks	Approx. curtain fullness	Stack depth A	Stack size B*	Min distance C
80	6	~2.1	140	180 per metre of track	90
80	7	~2.3	160	180 per metre of track	100

2C Glider cord SG 11303	Pockets between hooks	Approx. curtain fullness	Stack depth A	Stack size B*	Min distance C
60	4	~2.1	100	230 per metre of track	70
60	5	~2.3	120	230 per metre of track	80

\*Paketgröße B vergrößert sich um 95 mm pro Vorhangpaket bei Verwendung des optionalen Verlängerungsarms SG 6364!

# KOMPONENTEN

## A. STANDARD KOMPONENTEN



**SG 6065**

Feststeller

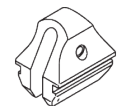

**SG 6086**

Verschlussfeder



**SG 6141**

Klemmstück



**SG 10492**

Linsenschraube M4x8

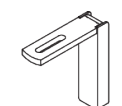

**SG 11206**

Smart Fix 60 mm mit Langloch

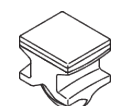

**SG 11305**

2C-Gleiter für direktes Annähen



**SG 11605**

Enddeckel bündig 50 mm

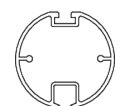

**SG 11609**

Profil

## B. OPTIONALE KOMPONENTEN

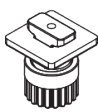

**SG 2255**

Bremse

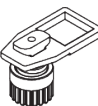

**SG 2256**

Bremse



**SG 3012**

Haken



**SG 3582**

Haken



**SG 3599**

Haken



**SG 6057**

Gleiter



**SG 6082**

Gleiter



**SG 6094**

Roller



**SG 6098**

Roller

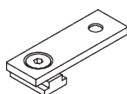

**SG 6151**

Deckenträgerset 3 mm

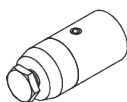

**SG 6175**

Mini Hänger



**SG 6283**

Roller



**SG 6349**

Wave Vorhangband



**SG 6363**

Wave Bügelband

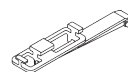

**SG 6364**

Wave Verlängerungsarm

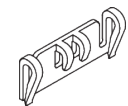

**SG 6365**

Wave Hänger

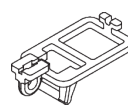

**SG 6366**

Wave Mitnehmer für Schleuderstab

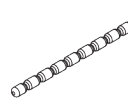

**SG 10075**

Bleischnur 50 gr/m

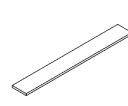

**SG 10076**

Beschwerung Seitensaum

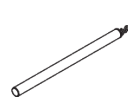

**SG 10430**

Schleuderstab 50 cm

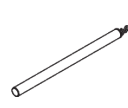

**SG 10431**

Schleuderstab 75 cm

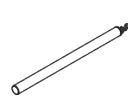

**SG 10432**

Schleuderstab 100 cm

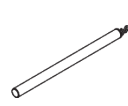

**SG 10433**

Schleuderstab 125 cm

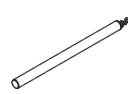

**SG 10434**

Schleuderstab 150 cm

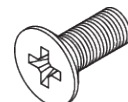

**SG 11127**

Senkkopfschraube M4x10



**SG 11131**

Linsenschraube mit Flansch M4x6

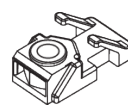

**SG 11148**

Mutter

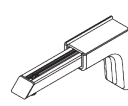

**SG 11154**

Universal Smart Fix 120 mm

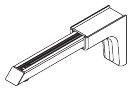

**SG 11155**  
Universal Smart Fix 150 mm

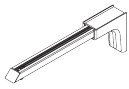

**SG 11156**  
Universal Smart Fix 200 mm

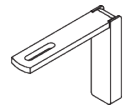

**SG 11207**  
Smart Fix 80 mm mit Langloch

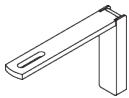

**SG 11208**  
Smart Fix 100 mm mit Langloch

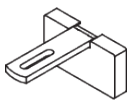

**SG 11216**  
Square Smart Fix 60 mm mit Langloch

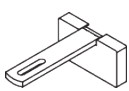

**SG 11217**  
Square Smart Fix 80 mm mit Langloch

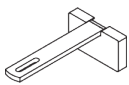

**SG 11218**  
Square Smart Fix 100 mm mit Langloch

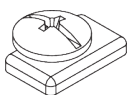

**SG 11295**  
Feststeller

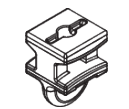

**SG 11300**  
2C-Gleiter



**SG 11301**  
2C-Gleiter am Strip

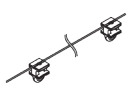

**SG 11302**  
Wave-2C-Gleiterkordel 80 mm

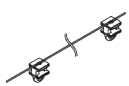

**SG 11303**  
Wave-2C-Gleiterkordel 60 mm



**SG 11651**  
Enddeckel Classic 50 mm

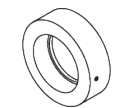

**SG 11652**  
Enddeckel Design 50 mm



**SG 11668**  
Top Fix Träger

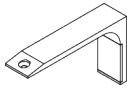

**SG 11669**  
Designträger

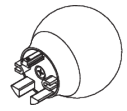

**SG 11776**  
Kugel 50 mm

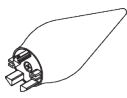

**SG 11777**  
Speer 50 mm



**SG 11778**  
Ellipse 50 mm

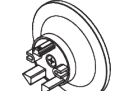

**SG 11779**  
Kegel 50 mm

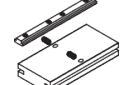

**SG 11783**  
Verbinder

## ***The Architects of Silence***

***Silent Gliss ist der weltweit führende Gesamtanbieter für hochwertigen innenliegenden Sicht- und Sonnenschutz. Mit modernster Technologie und unermüdlichem Präzisionsstreben werden in der Schweiz seit 1952 Beschattungssysteme entwickelt, die so lautlos und leichtgängig sind wie keine anderen auf der Welt.***

*Angetrieben von Kundenbedürfnissen bieten wir funktionelle und wartungsfreie Produkte nach Mass. Fachkundige technische Beratung im Wohn- und Objektbereich sowie Installations- und Supportdienstleistungen runden das Angebot ab. Silent Gliss steht für innovative, nachhaltige und komfortable Lösungen nach Mass, aussergewöhnliches Design und erstklassige Qualität.*

### **Silent Gliss AG**

Ostermundigenstrasse 99a  
3006 Bern

**T** +41 32 387 11 11

**F** +41 32 387 11 40

info@silentgliss.ch

**silentgliss.ch**