

# METROPOLE

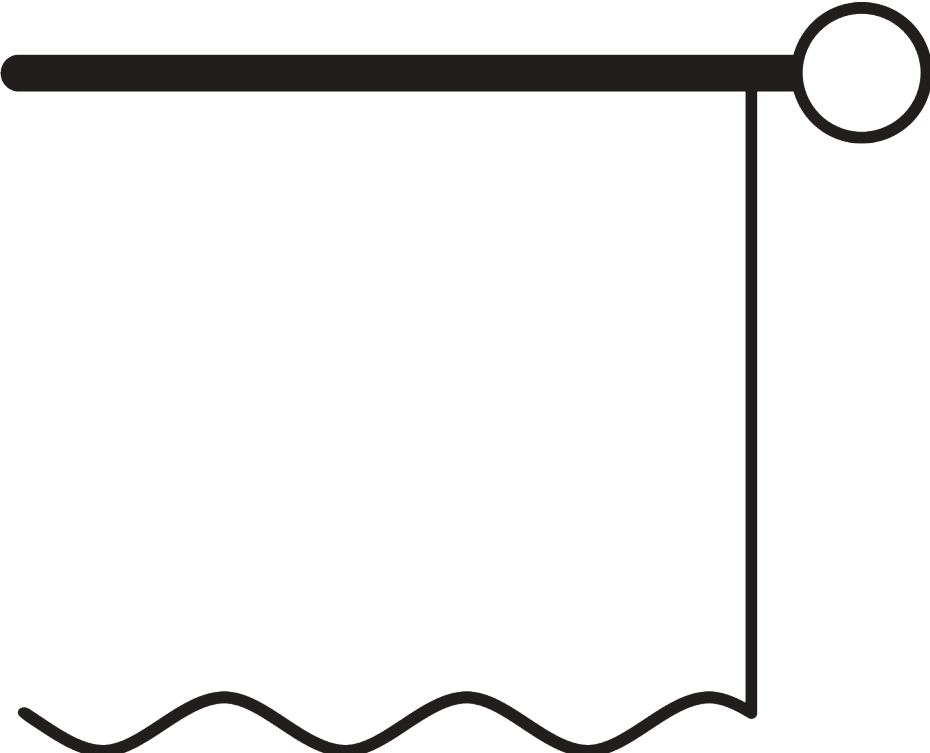

# INFORMATIONS GÉNÉRALES

## **Dimensions**

- Mesures en mm sauf indication contraire.
- Le poids maxi inclus le tissu et les accessoires.
- La taille du paquet rideau dépend de la confection et de l'épaisseur du tissu.
- Distance maxi entre glisseurs 80 mm / Distance maxi entre rouleurs 100 mm.
- Ecart recommandé entre bas du rideau et le sol: 20 mm.
- Pour déterminer la hauteur du système (B), la hauteur la plus petite doit être prise en compte.













## **Installation**

- Installation par poseur qualifié.
- Nombre de supports et points de fixation dépendent du poids du tissu, de la surface de pose, des vis utilisées et des obstacles.
- Les poseurs doivent utiliser les fixations appropriées à chaque situation.
- La lèvres du profil si elle existe doit être installée vers l'intérieur pièce.

## **Sécurité enfant**

- Tous les systèmes Silent Gliss concernés répondent à la norme sécurité EN 13120.
- Tous les intervenants doivent être en conformité avec la norme EN 13120.

# GUIDE D'UTILISATION

<u>PAGE</u>	<u>SYSTÈME</u>	<u>MODE DE COMMANDE</u>	<u>DIMENSION</u>	<u>DESIGN</u>	<u>WAVE</u>
5	<b>SG 7600</b>		S		
15	<b>SG 7605</b>		S - M		
25	<b>SG 7610</b>		S - M		
35	<b>SG 7620</b>		M - L		



# SG 7600

---

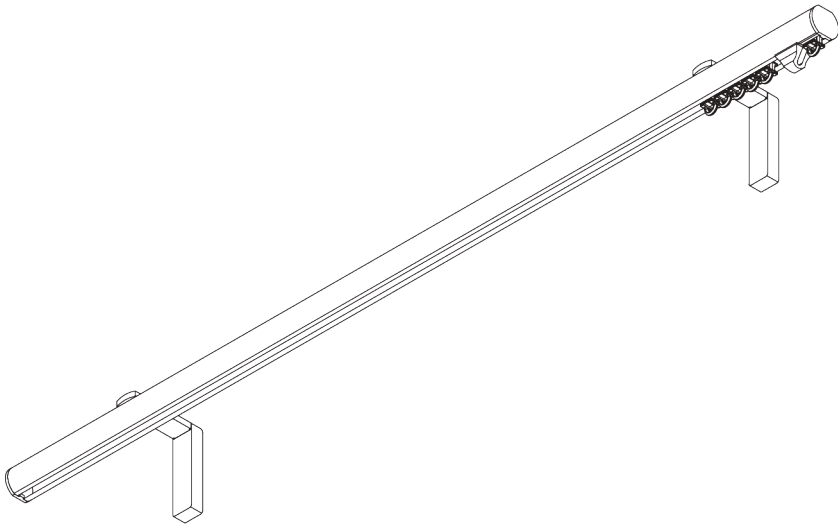
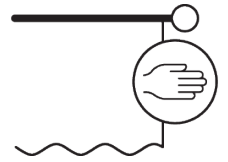

## INFORMATION PRODUIT

- **Mode de commande:** Tirage main
- **Gamme:** S
- **Installation:** Plafond, murale
- **Couleurs:** Blanc RAL 9016, couleurs spéciales possibles
- **Tissus:** Se référer à la collection tissu Silent Gliss

### **Caractéristiques:**

- Glisseurs Bi-Composants
- Option Glisseurs Wave Bi-Composants
- Couleurs assorties pour embouts et supports
- Collection d'embouts de finition
- Cintrable

# SPÉCIFICATION SYSTÈME

## A. PROFIL

Profil et information de cintrage

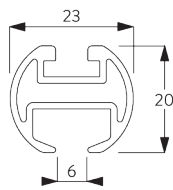

SG 11606

Profil

✓ Rayon:  
15 cm, 20 cm, >25 cm

## B. PRISE DE MESURE

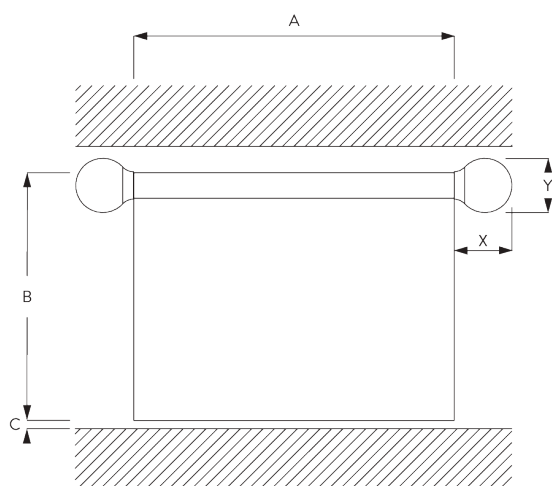

A: Largeur système sans les embouts décoratifs







B: Hauteur système

C: Distance entre bas du rideau et le sol

X: Largeur des embouts décoratifs

Y: Hauteur des embouts décoratifs

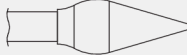
## Dimensions des embouts décoratifs

		23 mm	
		X	Y
	SG 11602	2	23
	SG 11621	8	27
	SG 11622	14	38
	SG 11726	49	46
	SG 11727	89	37
	SG 11728	20	69
	SG 11729	18	46

# INSTALLATION

## A. INSTRUCTION DE POSE

Pour des informations détaillées, se référer au site web Silent Gliss.

### Points de fixation

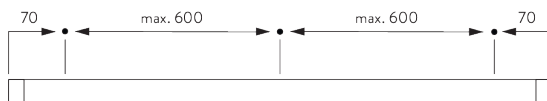

## B. FIXATION PLAFOND

### Support Top Fix SG 11668

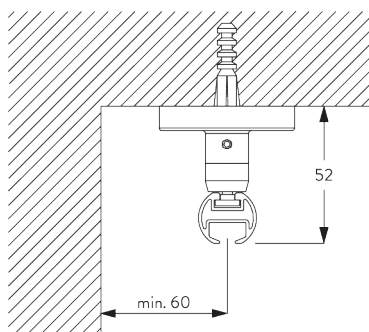

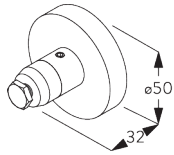

**SG 11668**

Support Top Fix

**Mini suspension  
SG 6175**

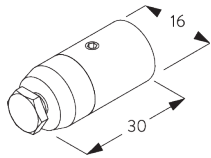
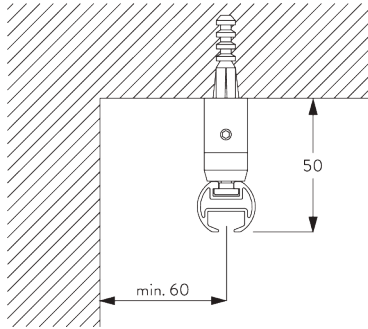

**SG 6175**

Mini suspension

**C. FIXATION  
MURALE**

**Smart Fix**

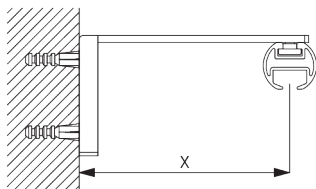

**Smart Fix avec fente SG 11206 - SG 11208 et SG 6141:**  
Vis SG 10492 (M4x10) nécessaire.

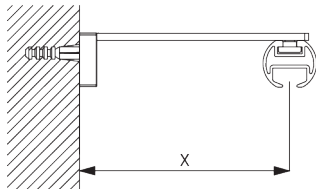

**Square Smart Fix avec fente SG 11216 - SG 11218  
et SG 6141:**  
Vis SG 10492 (M4x10) nécessaire.

Smart Fix	X mm	Y mm	Z mm
SG 11206 / SG 11216	51		
SG 11207 / SG 11217	71		
SG 11208 / SG 11218	91		
SG 11154	102-130		
SG 11155	132-160	68	65-72
SG 11156	182-210	68	65-123



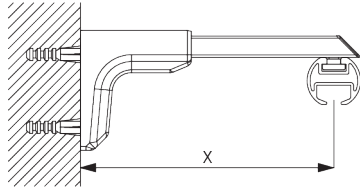

**Universal Smart Fix SG 11154 - SG 11156 et SG 6141:**

Vis SG 11131 (M4x6) nécessaire.

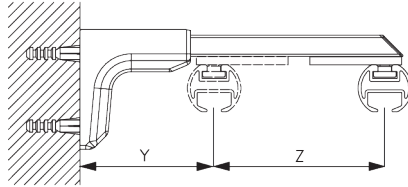

**Double système :**

**Universal Smart Fix SG 11155 - SG 11156 et SG 6151:**

Vis SG 11127 (M4x10) et écrou SG 11148 nécessaire.

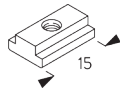

**SG 6141**

Écrou fixation

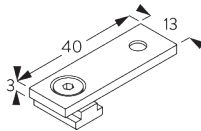

**SG 6151**

Support 3 mm



**SG 10492**

Vis M4x8



**SG 11127**

Vis M4x10



**SG 11131**

Vis M4x6



**SG 11148**

Écrou

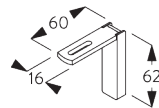

**SG 11206**

Smart Fix 60 mm avec fente

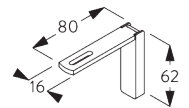

**SG 11207**

Smart Fix 80 mm avec fente

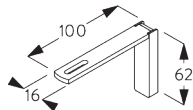

**SG 11208**

Smart Fix 100 mm avec fente

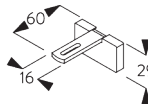

**SG 11216**

Square Smart Fix 60 mm avec fente

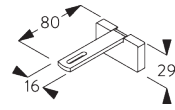

**SG 11217**

Square Smart Fix 80 mm avec fente

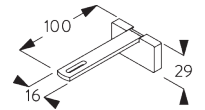

**SG 11218**

Square Smart Fix 100 mm avec fente

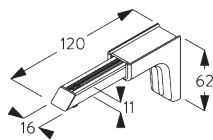

**SG 11154**

Universal Smart Fix 120 mm

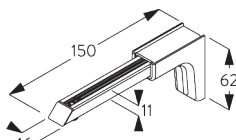

**SG 11155**

Universal Smart Fix 150 mm

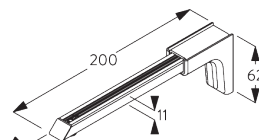

**SG 11156**

Universal Smart Fix 200 mm

## Support design SG 11669

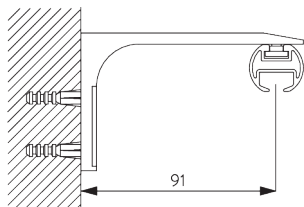

Vis SG 10492 (M4x8) nécessaire.  
Recommandé pour les systèmes droits uniquement.

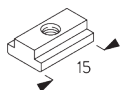

**SG 6141**  
Ecrou fixation



**SG 10492**  
Vis M4x8

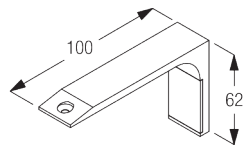

**SG 11669**  
Support design

# OPTIONS DÉSIGN & SYSTÈME

## A. EMBOUTS



SG 11602



SG 11621



SG 11622

Embouts:

- SG 11602 Embout Flush 23 mm
- SG 11621 Embout Stud 23 mm
- SG 11622 Embout Design 23 mm

Note:

- Sans embouts décoratives, les profils sont fournis en standard avec l'embout Flush SG 11602 (gauche)
- Alternativement, les embouts Stud SG 11621 sont disponibles.

## B. EMBOUTS DÉCORATIVES



SG 11726

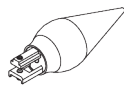

SG 11727



SG 11728



SG 11729

Les embouts décoratives sont des éléments décoratifs qui se fixent à l'extrémité des tringles:

- SG 11726 Ball 23 mm
- SG 11727 Spear 23 mm
- SG 11728 Ellipse 23 mm
- SG 11729 Taper 23 mm

## C. WAVE

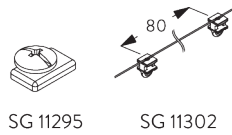
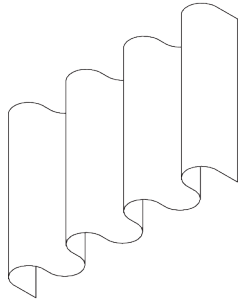

SG 11295

SG 11302

### Composants standards:

- SG 11295 Vis d'arrêt
- SG 11302 Glisseurs Wave bi-composants 80 mm

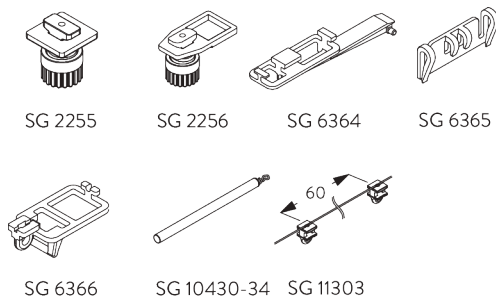

SG 2255

SG 2256

SG 6364

SG 6365

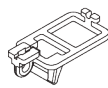

SG 6366

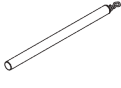

SG 10430-34

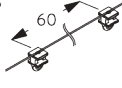

SG 11303

### Composants en option (rayon >25 cm):

- SG 2255 Frein
- SG 2256 Frein
- SG 6364 Extension Wave
- SG 6365 Crochet Wave
- SG 6366 Chariot Wave pour lance rideau
- SG 10430-34 Lance rideau
- SG 11303 Glisseur Wave bi-composants 60 mm

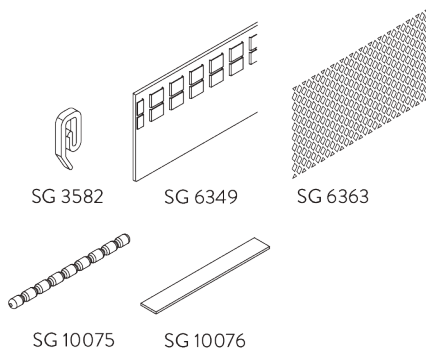

SG 3582

SG 6349

SG 6363

SG 10075

SG 10076

### Composants de rideaux:

- SG 3582 Crochet
- SG 6349 Ruban Wave transparent
- SG 6363 Ruban à repasser
- SG 10075 Fil à plomb 50 gr/m
- SG 10076 Barre de lestage

Paquet rideau Wave - Glisseur Bi-composants (standard)

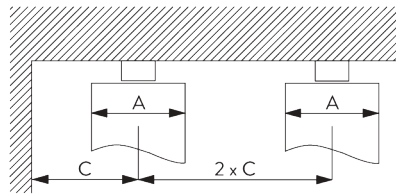
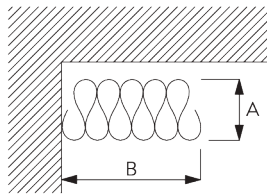

A = Epaisseur du Wave  
B = Largeur paquet rideau  
C = Ecartement minimum





Glisseur Bi-composants SG 11302	Nombre de poches entre crochets	Ampleur rideau Approximative	Epaisseur du Wave A	Largeur paquet rideau B*	Ecartement minimum C
80	6	~2.1	140	180 mm par ml de tringle	90
80	7	~2.3	160	180 mm par ml de tringle	100

Glisseur Bi-composants SG 11303	Nombre de poches entre crochets	Ampleur rideau Approximative	Epaisseur du Wave A	Largeur paquet rideau B*	Ecartement minimum C
60	4	~2.1	100	230 mm par ml de tringle	70
60	5	~2.3	120	230 mm par ml de tringle	80



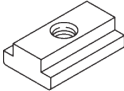
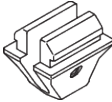
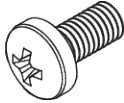
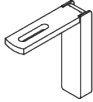

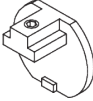



*\*Largeur paquet rideau B lors de l'utilisation du bras d'extension SG 6364 augmente de 95 mm par rideau!*

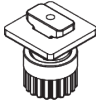
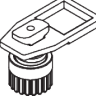



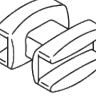
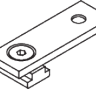
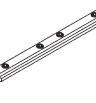
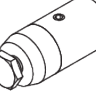

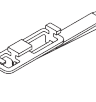
# ACCESSOIRES

## A. ACCESSOIRES STANDARDS

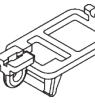
	<b>SG 6065</b> Fixateur avec oeillet
	<b>SG 6141</b> Ecroû fixation
	<b>SG 6245</b> Ressort d'arrêt
	<b>SG 10492</b> Vis M4x8
	<b>SG 11206</b> Smart Fix 60 mm avec fente
	<b>SG 11305</b> Glisseur Bi-composants pour couture directe
	<b>SG 11602</b> Embout Flush 23 mm
	<b>SG 11606</b> Profil

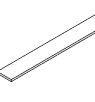
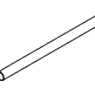
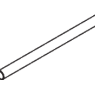
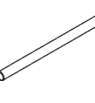
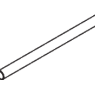
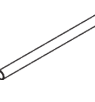
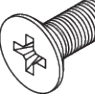
## B. ACCESSOIRES EN OPTION

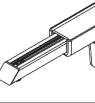
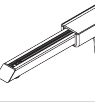
	<b>SG 2255</b> Frein
	<b>SG 2256</b> Frein
	<b>SG 3012</b> Agrafe à coudre
	<b>SG 3582</b> Agrafe Delrin
	<b>SG 3599</b> Crochet pour galon à froncer
	<b>SG 6057</b> Glisseur
	<b>SG 6082</b> Glisseur à coudre
	<b>SG 6151</b> Support 3 mm
	<b>SG 6173</b> Pont de connexion
	<b>SG 6175</b> Mini suspension
	<b>SG 6349</b> Ruban Wave transparent
	<b>SG 6363</b> Ruban à repasser
	<b>SG 6364</b> Extension
	<b>SG 6365</b> Crochet Wave

	<b>SG 6366</b> Chariot pour lance rideau
	<b>SG 10075</b> Fil à plomb 50 gr/m
	<b>SG 10076</b> Barre de lestage
	<b>SG 10430</b> Lance rideau aluminium avec crochet, 50cm
	<b>SG 10431</b> Lance rideau aluminium avec crochet, 75 cm
	<b>SG 10432</b> Lance rideau aluminium avec crochet, 100 cm
	<b>SG 10433</b> Lance rideau aluminium avec crochet, 125 cm
	<b>SG 10434</b> Lance rideau aluminium avec crochet, 150 cm
	<b>SG 11127</b> Vis M4x10
	<b>SG 11131</b> Vis M4x6
	<b>SG 11148</b> Ecroû
	<b>SG 11154</b> Universal Smart Fix 120 mm
	<b>SG 11155</b> Universal Smart Fix 150 mm
	<b>SG 11156</b> Universal Smart Fix 200 mm

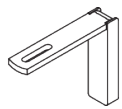
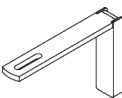
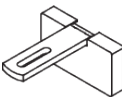
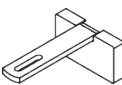
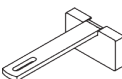
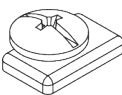
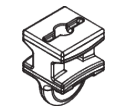
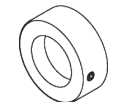
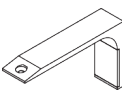
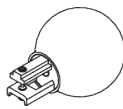
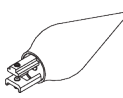
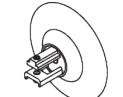
**SG 11207***Smart Fix 80 mm avec fente***SG 11208***Smart Fix 100 mm avec fente***SG 11216***Square Smart Fix 60 mm avec fente***SG 11217***Square Smart Fix 80 mm avec fente***SG 11218***Square Smart Fix 100 mm avec fente***SG 11295***Arrêt***SG 11300***Glisseur Bi-composants***SG 11301***Glisseur Bi-composants en barrette***SG 11302***Glisseur Wave Bi-composants 80 mm***SG 11303***Glisseur Wave Bi-composants 60 mm***SG 11621***Embout Stud 23 mm***SG 11622***Embout Design 23 mm***SG 11668***Support Top Fix***SG 11669***Support désign***SG 11726***Ball 23 mm***SG 11727***Spear 23 mm***SG 11728***Ellipse 23 mm***SG 11729***Taper 23 mm*

# SG 7605

---

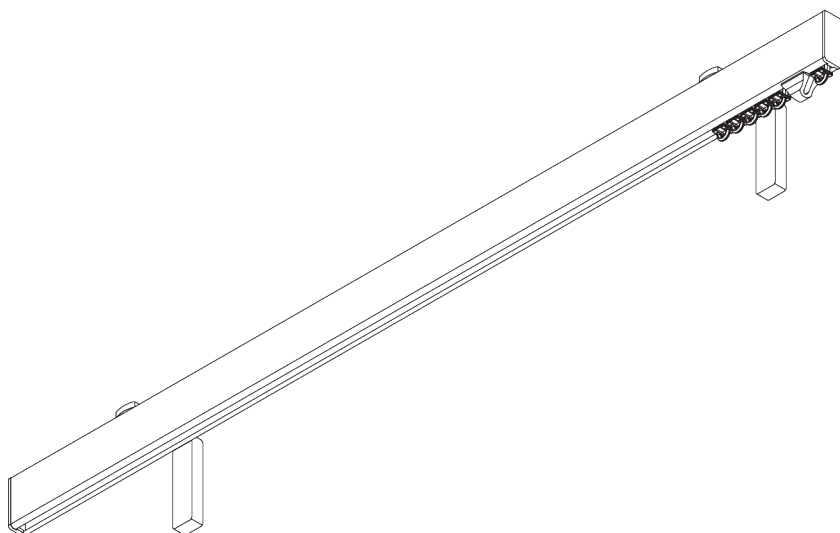
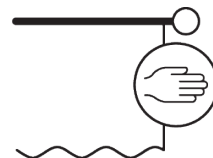

## INFORMATION PRODUIT

- **Mode de commande:** Tirage main
- **Gamme:** S - M
- **Installation:** Plafond, murale
- **Couleurs:** Blanc RAL 9016, couleurs spéciales possibles
- **Tissus:** Se référer à la collection tissu Silent Gliss

### **Caractéristiques:**

- Glisseurs Bi-Composants
- Option Glisseurs Wave Bi-Composants
- Couleurs assorties pour embouts et supports
- Cintrable

# SPÉCIFICATION SYSTÈME

## A. PROFIL

Profil et information de cintrage

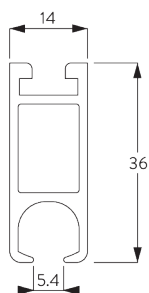

**SG 6101**

Profil

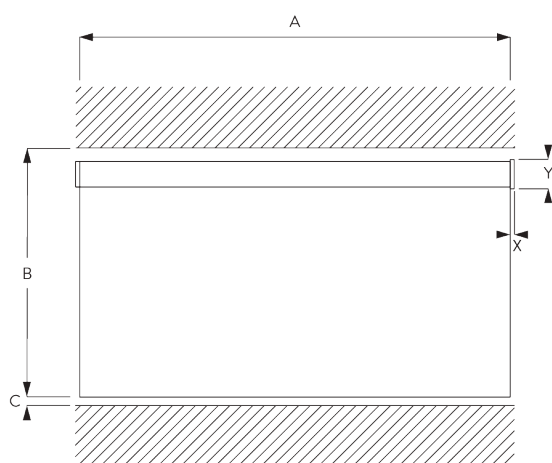

Rayon:  
✓ 20 cm, >25 cm

## B. PRISE DE MESURE



A: Largeur système sans les embouts  
B: Hauteur système  
C: Distance entre bas du rideau et le sol  
X: Largeur des embouts  
Y: Hauteur des embouts

## Dimensions des embouts

		36 mm	
		X	Y
	SG 11601	2	36
	SG 11611	5	40



# INSTALLATION

## A. INSTRUCTION DE POSE

Pour des informations détaillées, se référer au site web  
Silent Gliss.

### Points de fixation

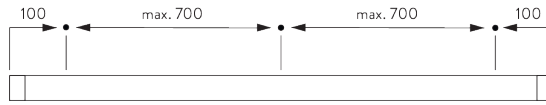

## B. FIXATION PLAFOND

### Support Top Fix SG 11668

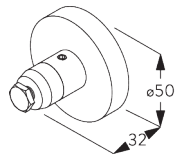
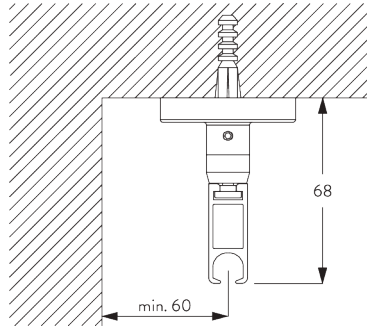

**SG 11668**

Support Top Fix

### Mini suspension SG 6175

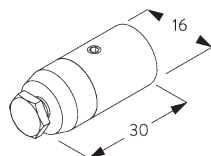
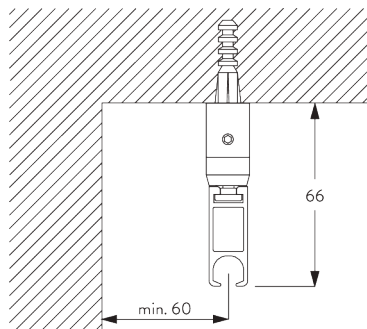

**SG 6175**

Mini suspension

## C. FIXATION MURALE

### Smart Fix

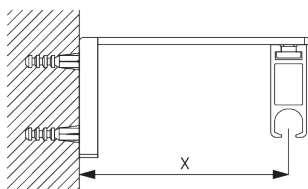

**Smart Fix avec fente SG 11206 - SG 11208 et SG 6141:**  
Vis SG 10492 (M4x10) nécessaire.

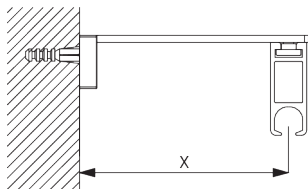

**Square Smart Fix avec fente SG 11216 - SG 11218 et SG 6141:**  
Vis SG 10492 (M4x10) nécessaire.

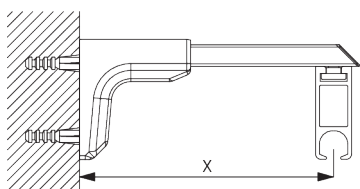

**Universal Smart Fix SG 11154 - SG 11156 et SG 6141:**  
Vis SG 11131 (M4x6) nécessaire.

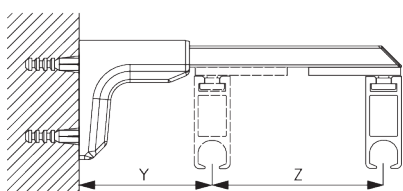

**Double système :**  
**Universal Smart Fix SG 11155 - SG 11156 et SG 6151:**  
Vis SG 11127 (M4x10) et écrou SG 11148 nécessaire.

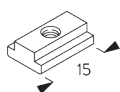

**SG 6141**  
Ecrou fixation

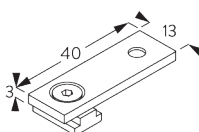

**SG 6151**  
Support 3 mm



**SG 10492**  
Vis M4x8



**SG 11127**  
Vis M4x10



**SG 11131**  
Vis M4x6



**SG 11148**  
Ecrou

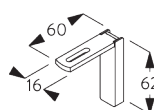

**SG 11206**  
Smart Fix 60 mm avec fente

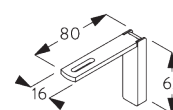

**SG 11207**  
Smart Fix 80 mm avec fente

Smart Fix	X mm	Y mm	Z mm
SG 11206 / SG 11216	51		
SG 11207 / SG 11217	71		
SG 11208 / SG 11218	91		
SG 11154	102-130		
SG 11155	132-160	68	65-72
SG 11156	182-210	68	65-123

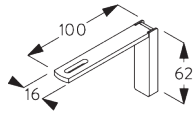

**SG 11208**

Smart Fix 100 mm avec fente

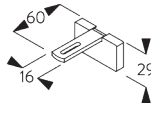

**SG 11216**

Square Smart Fix 60 mm avec fente

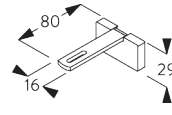

**SG 11217**

Square Smart Fix 80 mm avec fente

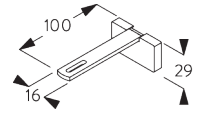

**SG 11218**

Square Smart Fix 100 mm avec fente

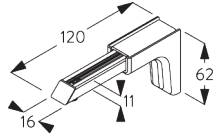

**SG 11154**

Universal Smart Fix 120 mm

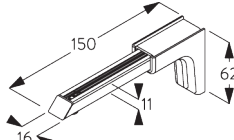

**SG 11155**

Universal Smart Fix 150 mm

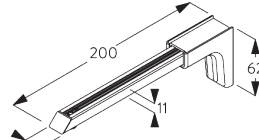

**SG 11156**

Universal Smart Fix 200 mm

## Support design SG 11669

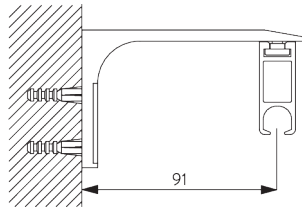

Vis SG 10492 (M4x8) nécessaire.  
Recommandé pour les systèmes droits uniquement.

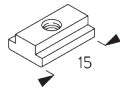

**SG 6141**

Ecrou fixation



**SG 10492**

Vis M4x8

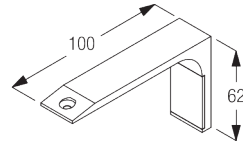

**SG 11669**

Support design

# OPTIONS DÉSIGN & SYSTÈME

## A. EMBOUTS



SG 11601



SG 11611

Note:

- Les profils sont fournis en standard avec l'embout Flush SG 11601 (gauche)
- Alternativement, les embouts Stud SG 11611 sont disponibles.

## B. WAVE

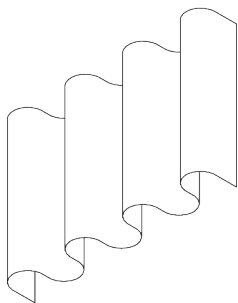

SG 11295

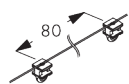

SG 11302

### Composants standards:

- SG 11295 Vis d'arrêt
- SG 11302 Glisseurs Wave bi-composants 80 mm



SG 2255



SG 2256

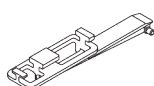

SG 6364



SG 6365

### Composants en option (rayon >25 cm):

- SG 2255 Frein
- SG 2256 Frein
- SG 6364 Extension Wave
- SG 6365 Crochet Wave
- SG 6366 Chariot Wave pour lance rideau
- SG 10430-34 Lance rideau
- SG 11303 Glisseur Wave bi-composants 60 mm

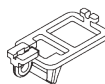

SG 6366

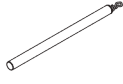

SG 10430-34

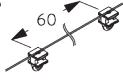

SG 11303



SG 3582

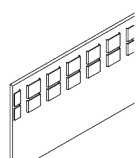

SG 6349

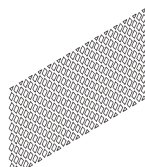

SG 6363

### Composants de rideaux:

- SG 3582 Crochet
- SG 6349 Ruban Wave transparent
- SG 6363 Ruban à repasser
- SG 10075 Fil à plomb 50 gr/m
- SG 10076 Barre de lestage

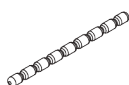

SG 10075



SG 10076

Paquet rideau Wave - Glisseur Bi-composants (standard)

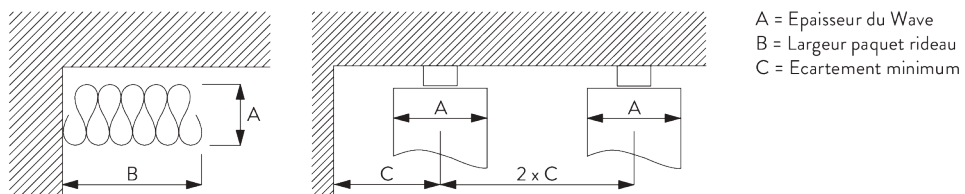

A = Epaisseur du Wave  
 B = Largeur paquet rideau  
 C = Ecartement minimum

Glisseur Bi-composants SG 11302	Nombre de poches entre crochets	Ampleur rideau Approximative	Epaisseur du Wave A	Largeur paquet rideau B*	Ecartement minimum C
80	6	~2.1	140	180 mm par ml de triangle	90
80	7	~2.3	160	180 mm par ml de triangle	100

Glisseur Bi-composants SG 11303	Nombre de poches entre crochets	Ampleur rideau Approximative	Epaisseur du Wave A	Largeur paquet rideau B*	Ecartement minimum C
60	4	~2.1	100	230 mm par ml de triangle	70
60	5	~2.3	120	230 mm par ml de triangle	80

\*Largeur paquet rideau B lors de l'utilisation du bras d'extension SG 6364 augmente de 95 mm par rideau!

# ACCESSOIRES

## A. ACCESSOIRES STANDARDS



**SG 6065**

Fixateur avec oeillet

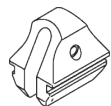

**SG 6086**

Ressort d'arrêt delrin



**SG 6101**

Profil



**SG 6141**

Ecrou fixation



**SG 10492**

Vis M4x8

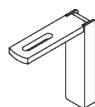

**SG 11206**

Smart Fix 60 mm avec fente

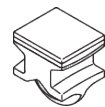

**SG 11305**

Glisseur Bi-composants pour couture directe

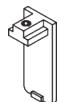

**SG 11601**

Embout Flush 36 mm

## B. ACCESSOIRES EN OPTION

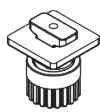

**SG 2255**

Frein

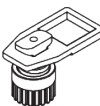

**SG 2256**

Frein



**SG 3012**

Agrafe à coudre



**SG 3582**

Agrafe Delrin



**SG 3599**

Crochet pour galon à froncer



**SG 6053**

Ressort d'arrêt



**SG 6057**

Glisseur

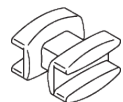

**SG 6082**

Glisseur à coudre



**SG 6094**

Rouleau



**SG 6098**

Rouleau

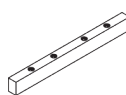

**SG 6112**

Pont de connexion

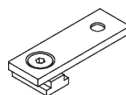

**SG 6151**

Support 3 mm

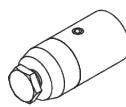

**SG 6175**

Mini suspension



**SG 6283**

Rouleau

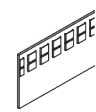

**SG 6349**

Ruban Wave transparent



**SG 6363**

Ruban à repasser

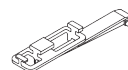

**SG 6364**

Extension

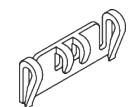

**SG 6365**

Crochet Wave

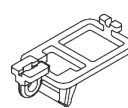

**SG 6366**

Chariot pour lance rideau

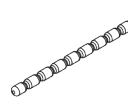

**SG 10075**

Fil à plomb 50 gr/m

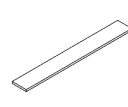

**SG 10076**

Barre de lestage

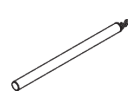

**SG 10430**

Lance rideau aluminium avec crochet, 50cm

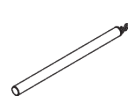

**SG 10431**

Lance rideau aluminium avec crochet, 75 cm

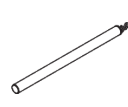

**SG 10432**

Lance rideau aluminium avec crochet, 100 cm

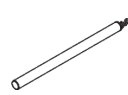

**SG 10433**

Lance rideau aluminium avec crochet, 125 cm

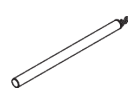

**SG 10434**

Lance rideau aluminium avec crochet, 150 cm

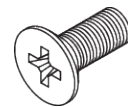

**SG 11127**

Vis M4x10

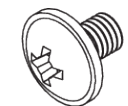

**SG 11131**

Vis M4x6

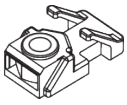
**SG 11148**

Ecrou

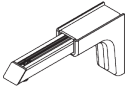
**SG 11154**

Universal Smart Fix 120 mm

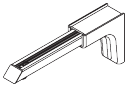
**SG 11155**

Universal Smart Fix 150 mm

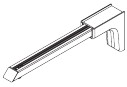
**SG 11156**

Universal Smart Fix 200 mm

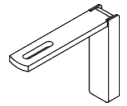
**SG 11207**

Smart Fix 80 mm avec fente

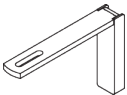
**SG 11208**

Smart Fix 100 mm avec fente

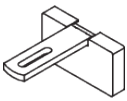
**SG 11216**

Square Smart Fix 60 mm avec fente

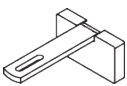
**SG 11217**

Square Smart Fix 80 mm avec fente

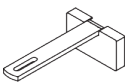
**SG 11218**

Square Smart Fix 100 mm avec fente

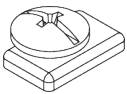
**SG 11295**

Arrêt

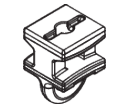
**SG 11300**

Glisseur Bi-composants

**SG 11301**

Glisseur Bi-composants en barrette

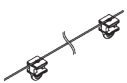
**SG 11302**

Glisseur Wave Bi-composants 80 mm

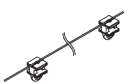
**SG 11303**

Glisseur Wave Bi-composants 60 mm

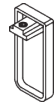
**SG 11611**

Embout Stud 36 mm

**SG 11668**

Support Top Fix

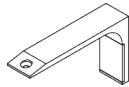
**SG 11669**

Support désign





# SG 7610

---

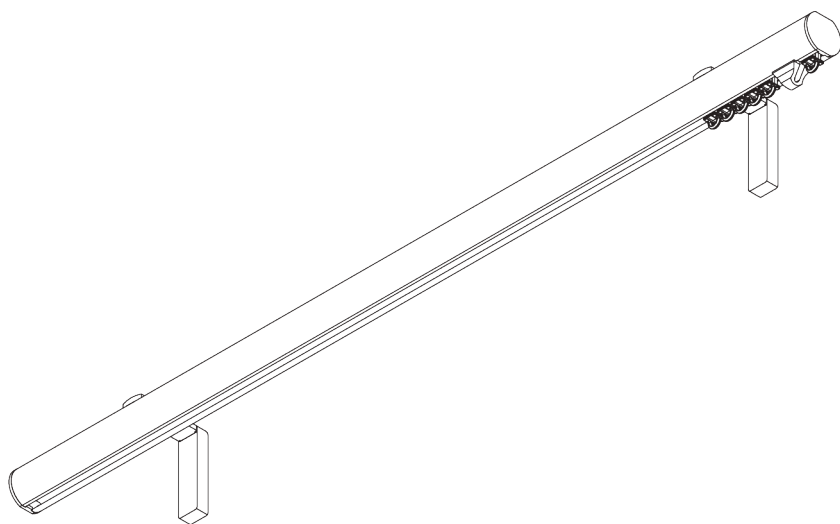
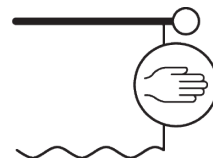

## PRODUCT INFORMATION

- **Mode de commande:** Tirage main
- **Gamme:** S - M
- **Installation:** Plafond, murale
- **Couleurs:** Blanc RAL 9016, couleurs spéciales possibles
- **Tissus:** Se référer à la collection tissu Silent Gliss

### **Caractéristiques:**

- Glisseurs Bi-Composants
- Option Glisseurs Wave Bi-Composants
- Couleurs assorties pour embouts et supports
- Collection d'embouts de finition
- Cintrable

# SPÉCIFICATION SYSTÈME

## A. PROFIL

Profil et information de cintrage

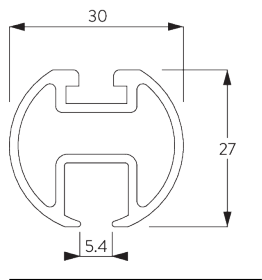

SG 6103p

Profil

Rayon:  
✓ >25 cm

## B. PRISE DE MESURE

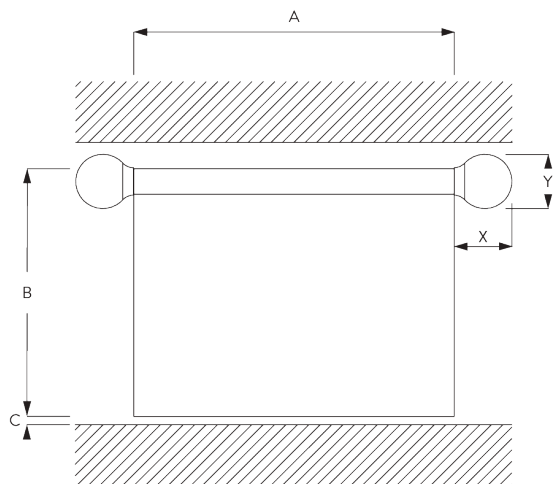

A: Largeur système sans les embouts décoratifs







B: Hauteur système

C: Distance entre bas du rideau et le sol

X: Largeur des embouts décoratifs

Y: Hauteur des embouts décoratifs

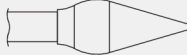
## Dimensions des embouts décoratifs

		30 mm	
		X	Y
	SG 11603	2	30
	SG 11631	10	34
	SG 11632	18	50
	SG 11746	64	60
	SG 11747	116	48
	SG 11748	26	90
	SG 11749	20	60

# INSTALLATION

## A. INSTRUCTION DE POSE

Pour des informations détaillées, se référer au site web Silent Gliss.

### Points de fixation

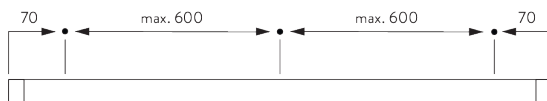

## B. FIXATION PLAFOND

### Support Top Fix SG 11668

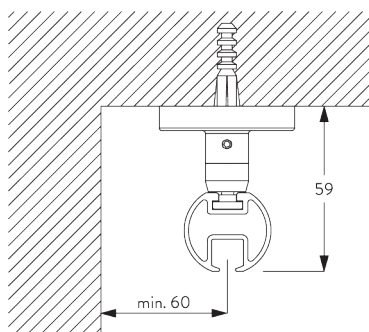

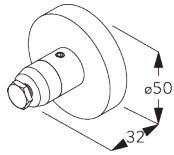

**SG 11668**

Support Top Fix

**Mini suspension  
SG 6175**

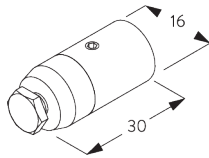
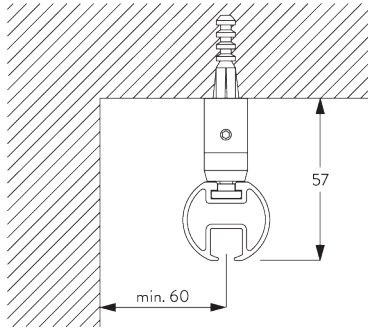

**SG 6175**

Mini suspension

**C. FIXATION  
MURALE**

**Smart Fix**

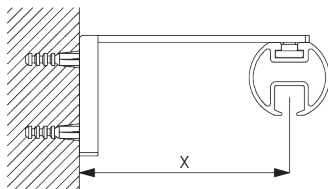

**Smart Fix avec fente SG 11206 - SG 11208 et SG 6141:**  
Vis SG 10492 (M4x10) nécessaire.

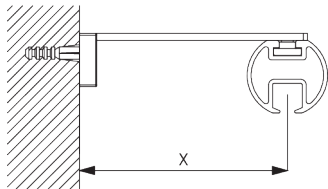

**Square Smart Fix avec fente SG 11216 - SG 11218  
et SG 6141:**  
Vis SG 10492 (M4x10) nécessaire.

Smart Fix	X mm	Y mm	Z mm
SG 11206 / SG 11216	51		
SG 11207 / SG 11217	71		
SG 11208 / SG 11218	91		
SG 11154	102-130		
SG 11155	132-160	68	65-72
SG 11156	182-210	68	65-123

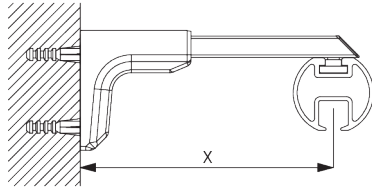

**Universal Smart Fix SG 11154 - SG 11156 et SG 6141:**

Vis SG 11131 (M4x6) nécessaire.

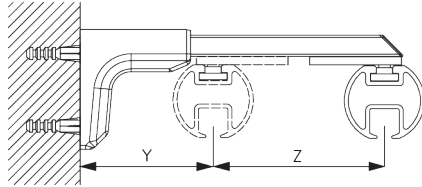

**Double système :**

**Universal Smart Fix SG 11155 - SG 11156 et SG 6151:**

Vis SG 11127 (M4x10) et écrou SG 11148 nécessaire.

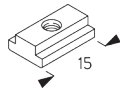

**SG 6141**

Ecrou fixation

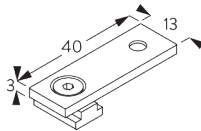

**SG 6151**

Support 3 mm



**SG 10492**

Vis M4x8



**SG 11127**

Vis M4x10



**SG 11131**

Vis M4x6



**SG 11148**

Ecrou

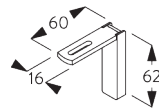

**SG 11206**

Smart Fix 60 mm avec fente

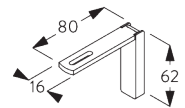

**SG 11207**

Smart Fix 80 mm avec fente

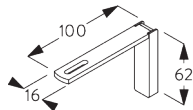

**SG 11208**

Smart Fix 100 mm avec fente

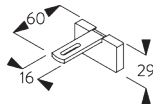

**SG 11216**

Square Smart Fix 60 mm avec fente

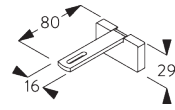

**SG 11217**

Square Smart Fix 80 mm avec fente

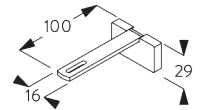

**SG 11218**

Square Smart Fix 100 mm avec fente

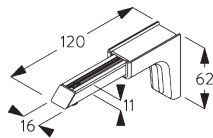

**SG 11154**

Universal Smart Fix 120 mm

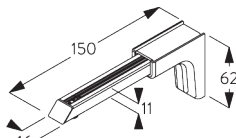

**SG 11155**

Universal Smart Fix 150 mm

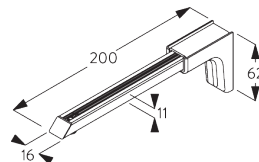

**SG 11156**

Universal Smart Fix 200 mm

## Support désign SG 11669

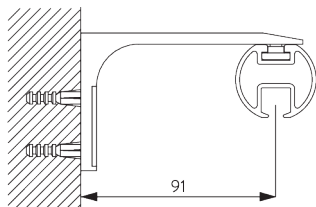

Vis SG 10492 (M4x8) nécessaire.  
Recommandé pour les systèmes droits uniquement.

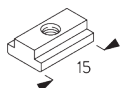

**SG 6141**  
Ecrou fixation



**SG 10492**  
Vis M4x8

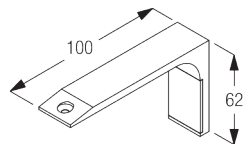

**SG 11669**  
Support désign

# OPTIONS DÉSIGN & SYSTÈME

## A. EMBOUTS



SG 11603



SG 11631



SG 11632

Embouts:

- SG 11603 Embout Flush 30 mm
- SG 11631 Embout Stud 30 mm
- SG 11632 Embout Design 30 mm

Note:

- Sans embouts décoratives, les profils sont fournis en standard avec l'embout Flush SG 11603 (gauche)
- Alternativement, les embouts Stud SG 11631 sont disponibles.

## B. EMBOUTS DÉCORATIVES



SG 11746



SG 11747



SG 11748



SG 11749

Finials are decorative elements that fit on at the end of the pole:

- SG 11746 Ball end 30 mm
- SG 11747 Spear 30 mm
- SG 11748 Ellipse 30 mm
- SG 11749 Taper 30 mm

## C. WAVE

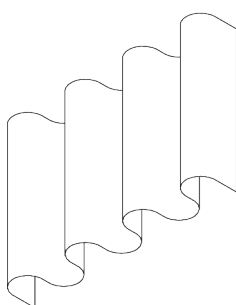

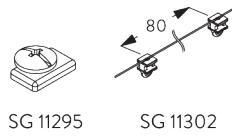

SG 11295

SG 11302

**Composants standards:**

- SG 11295 Vis d'arrêt
- SG 11302 Glisseurs Wave bi-composants 80 mm

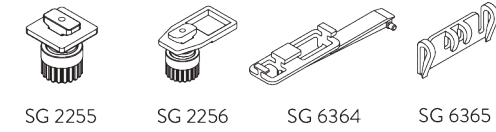

SG 2255

SG 2256

SG 6364

SG 6365

**Composants en option:**

- SG 2255 Frein
- SG 2256 Frein
- SG 6364 Extension Wave
- SG 6365 Crochet Wave
- SG 6366 Chariot Wave pour lance rideau
- SG 10430-34 Lance rideau
- SG 11303 Glisseur Wave bi-composants 60 mm



SG 6366

SG 10430-34

SG 11303

**Composants de rideaux:**

- SG 3582 Crochet
- SG 6349 Ruban Wave transparent
- SG 6363 Ruban à repasser
- SG 10075 Fil à plomb 50 gr/m
- SG 10076 Barre de lestage

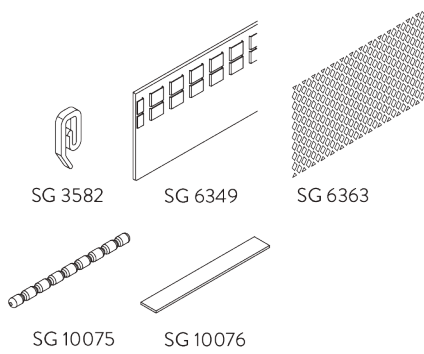

SG 3582

SG 6349

SG 6363

SG 10075

SG 10076

**Wave stack depth - 2C glider cord (standard components)**

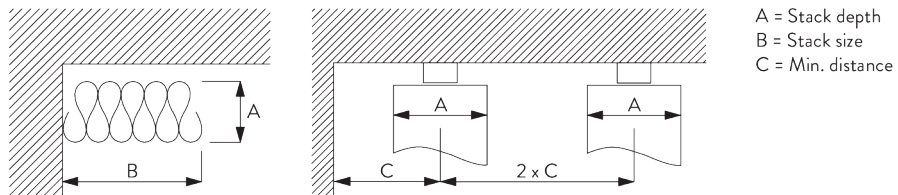

A = Stack depth  
B = Stack size  
C = Min. distance

2C Glider cord SG 11302	Pockets between hooks	Approx. curtain fullness	Stack depth A	Stack size B*	Min distance C
80	6	~2.1	140	180 per metre of track	90
80	7	~2.3	160	180 per metre of track	100

2C Glider cord SG 11303	Pockets between hooks	Approx. curtain fullness	Stack depth A	Stack size B*	Min distance C
60	4	~2.1	100	230 per metre of track	70
60	5	~2.3	120	230 per metre of track	80

\*Largeur paquet rideau B lors de l'utilisation du bras d'extension SG 6364 augmente de 95 mm par rideau!

# ACCESSOIRES

## A. ACCESSOIRES STANDARDS



**SG 6065**

Fixateur avec oeillet

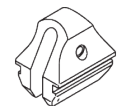

**SG 6086**

Ressort d'arrêt delrin



**SG 6103p**

Profil

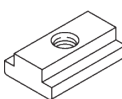

**SG 6141**

Ecroû fixation



**SG 10492**

Vis M4x8

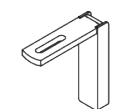

**SG 11206**

Smart Fix 60 mm avec fente

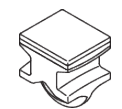

**SG 11305**

Glisseur Bi-composants pour couture directe

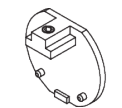

**SG 11603**

Embout Flush 30 mm

## B. ACCESSOIRES EN OPTION

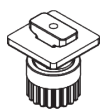

**SG 2255**

Frein

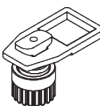

**SG 2256**

Frein



**SG 3012**

Agrafe à coudre



**SG 3582**

Agrafe Delrin



**SG 3599**

Crochet pour galon à froncer



**SG 6057**

Glisseur



**SG 6082**

Glisseur à coudre



**SG 6094**

Rouleau



**SG 6098**

Rouleau

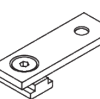

**SG 6151**

Support 3 mm

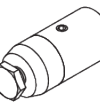

**SG 6175**

Mini suspension



**SG 6283**

Rouleau



**SG 6349**

Ruban Wave transparent



**SG 6363**

Ruban à repasser

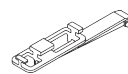

**SG 6364**

Extension

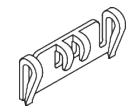

**SG 6365**

Crochet Wave

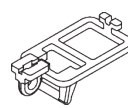

**SG 6366**

Chariot pour lance rideau

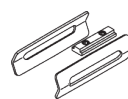

**SG 6635**

Pièce de raccord

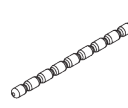

**SG 10075**

Fil à plomb 50 gr/m

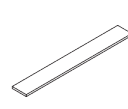

**SG 10076**

Barre de lestage

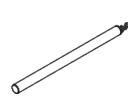

**SG 10430**

Lance rideau aluminium avec crochet, 50cm

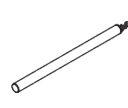

**SG 10431**

Lance rideau aluminium avec crochet, 75 cm

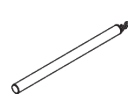

**SG 10432**

Lance rideau aluminium avec crochet, 100 cm

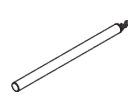

**SG 10433**

Lance rideau aluminium avec crochet, 125 cm

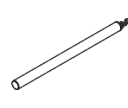

**SG 10434**

Lance rideau aluminium avec crochet, 150 cm

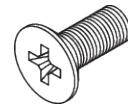

**SG 11127**

Vis M4x10

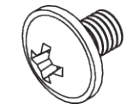

**SG 11131**

Vis M4x6

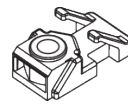

**SG 11148**

Ecroû



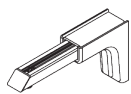

**SG 11154**  
Universal Smart Fix 120 mm

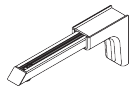

**SG 11155**  
Universal Smart Fix 150 mm



**SG 11156**  
Universal Smart Fix 200 mm

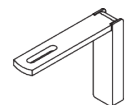

**SG 11207**  
Smart Fix 80 mm avec fente

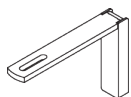

**SG 11208**  
Smart Fix 100 mm avec fente

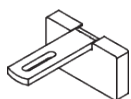

**SG 11216**  
Square Smart Fix 60 mm avec fente

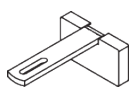

**SG 11217**  
Square Smart Fix 80 mm avec fente

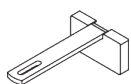

**SG 11218**  
Square Smart Fix 100 mm avec fente

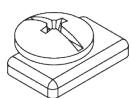

**SG 11295**  
Arrêt

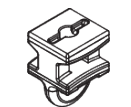

**SG 11300**  
Glisseur Bi-composants



**SG 11301**  
Glisseur Bi-composants en barrette

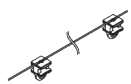

**SG 11302**  
Glisseur Wave Bi-composants 80 mm

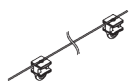

**SG 11303**  
Glisseur Wave Bi-composants 60 mm



**SG 11631**  
Embout Stud 30 mm

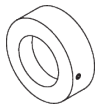

**SG 11632**  
Embout Design 30 mm



**SG 11668**  
Support Top Fix

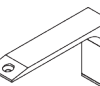

**SG 11669**  
Support désign



**SG 11746**  
Ball 30 mm

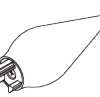

**SG 11747**  
Spear 30 mm



**SG 11748**  
Ellipse 30 mm



**SG 11749**  
Taper 30 mm



# SG 7620

---

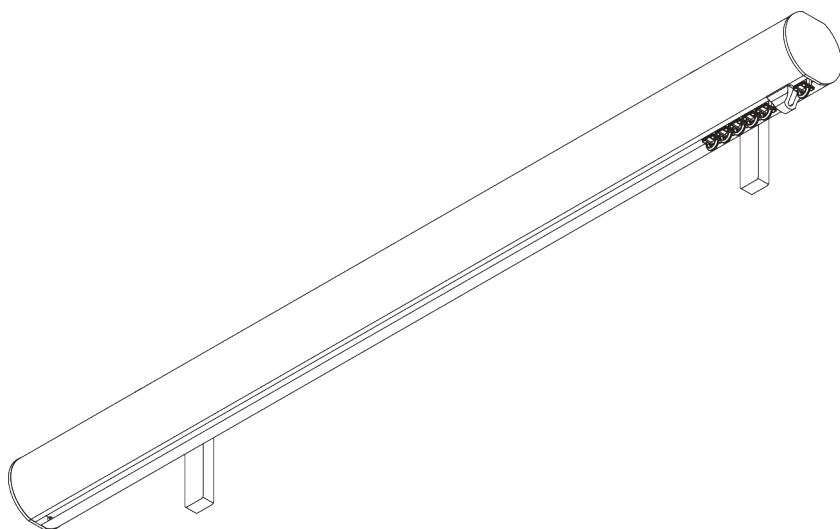
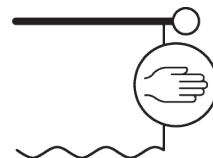

## INFORMATION PRODUIT

- **Mode de commande:** Tirage main
- **Gamme:** M - L
- **Installation:** Plafond, murale
- **Couleurs:** Blanc RAL 9016, couleurs spéciales possibles
- **Tissus:** Se référer à la collection tissu Silent Gliss

### **Caractéristiques:**

- Glisseurs Bi-Composants
- Option Glisseurs Wave Bi-Composants
- Couleurs assorties pour embouts et supports
- Collection d'embouts de finition
- Cintrable

# SPÉCIFICATION SYSTÈME

## A. PROFIL

Profil et information de cintrage

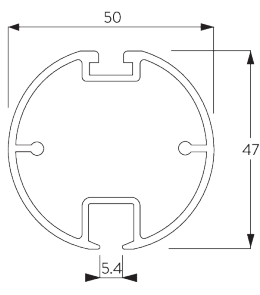

SG 11609

Profil

Rayon:  
>50 cm

## B. PRISE DE MESURE

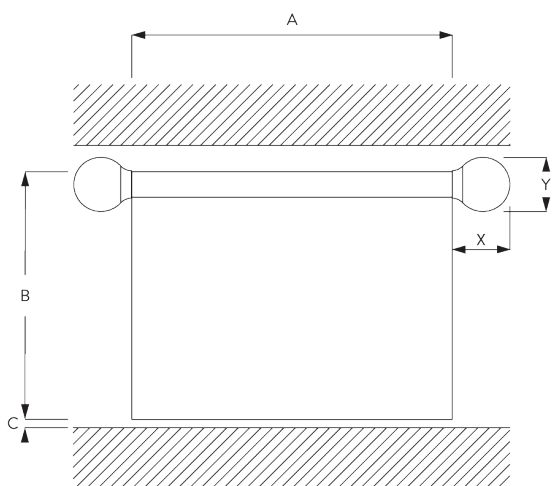

A: Largeur système sans les embouts décoratifs







B: Hauteur système

C: Distance entre bas du rideau et le sol

X: Largeur des embouts décoratifs

Y: Hauteur des embouts décoratifs

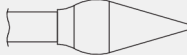
## Dimensions des embouts décoratifs

		50 mm	
		X	Y
	SG 11605	2	51
	SG 11651	10	56
	SG 11652	24	75
	SG 11776	90	85
	SG 11777	165	70
	SG 11778	32	130
	SG 11779	30	100

# INSTALLATION

## A. INSTRUCTION DE POSE

Pour des informations détaillées, se référer au site web Silent Gliss.

### Points de fixation

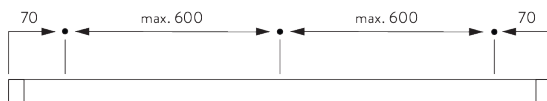

## B. FIXATION PLAFOND

### Support Top Fix SG 11668

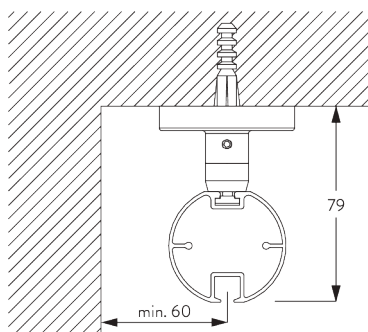

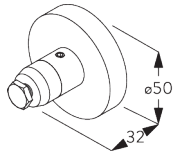

**SG 11668**

Support Top Fix

**Mini suspension  
SG 6175**

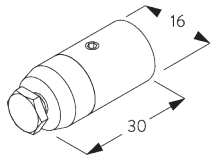
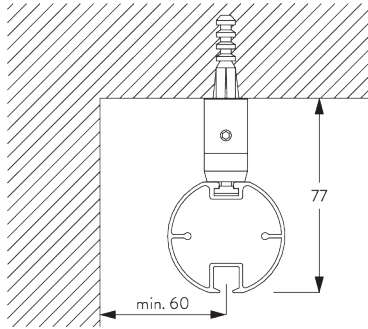

**SG 6175**

Mini suspension

**C. FIXATION  
MURALE**

**Smart Fix**

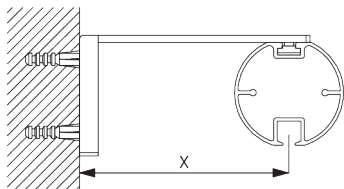

**Smart Fix avec fente SG 11206 - SG 11208 et SG 6141:**  
Vis SG 10492 (M4x10) nécessaire.

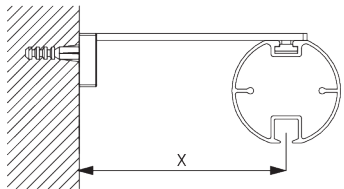

**Square Smart Fix avec fente SG 11216 - SG 11218  
et SG 6141:**  
Vis SG 10492 (M4x10) nécessaire.

Smart Fix	X mm	Y mm	Z mm
SG 11206 / SG 11216	51		
SG 11207 / SG 11217	71		
SG 11208 / SG 11218	91		
SG 11154	102-130		
SG 11155	132-160	68	65-72
SG 11156	182-210	68	65-123

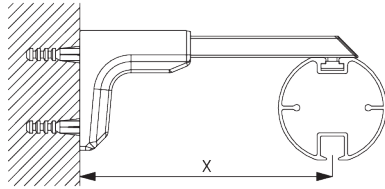

**Universal Smart Fix SG 11154 - SG 11156 et SG 6141:**

Vis SG 11131 (M4x6) nécessaire.

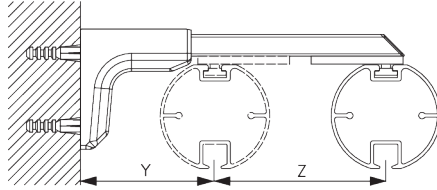

**Double système :**

**Universal Smart Fix SG 11155 - SG 11156 et SG 6151:**

Vis SG 11127 (M4x10) et écrou SG 11148 nécessaire.

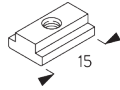

**SG 6141**

Ecrou fixation

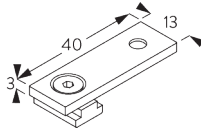

**SG 6151**

Support 3 mm



**SG 10492**

Vis M4x8



**SG 11127**

Vis M4x10



**SG 11131**

Vis M4x6



**SG 11148**

Ecrou

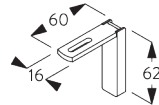

**SG 11206**

Smart Fix 60 mm avec fente

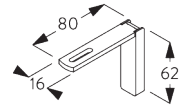

**SG 11207**

Smart Fix 80 mm avec fente

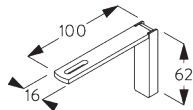

**SG 11208**

Smart Fix 100 mm avec fente

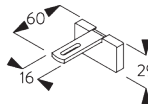

**SG 11216**

Square Smart Fix 60 mm avec fente

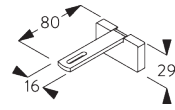

**SG 11217**

Square Smart Fix 80 mm avec fente

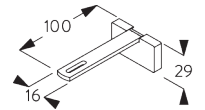

**SG 11218**

Square Smart Fix 100 mm avec fente

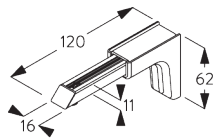

**SG 11154**

Universal Smart Fix 120 mm

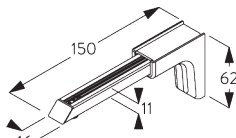

**SG 11155**

Universal Smart Fix 150 mm

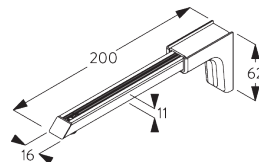

**SG 11156**

Universal Smart Fix 200 mm

## Support désign SG 11669

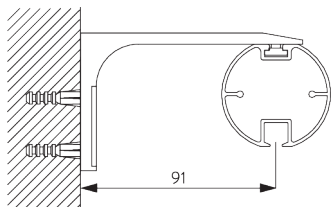

Vis SG 10492 (M4x8) nécessaire.  
Recommandé pour les systèmes droits uniquement.

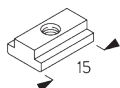

**SG 6141**  
Ecrou fixation



**SG 10492**  
Vis M4x8

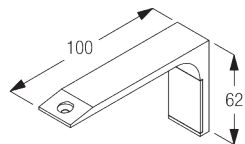

**SG 11669**  
Support désign

# OPTIONS DÉSIGN & SYSTÈME

## A. EMBOUTS



SG 11605



SG 11651



SG 11652

Embouts:

- SG 11605 Embout Flush 50 mm
- SG 11651 Embout Stud 50 mm
- SG 11652 Embout Design 50 mm

Note:

- Sans embouts décoratives, les profils sont fournis en standard avec l'embout Flush SG 11605 (gauche)
- Alternativement, les embouts Stud SG 11651 sont disponibles.

## B. EMBOUTS DÉCORATIVES



SG 11776

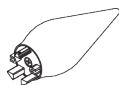

SG 11777



SG 11778



SG 11779

Les embouts décoratives sont des éléments décoratifs qui se fixent à l'extrémité des tringles:

- SG 11776 Ball 50 mm
- SG 11777 Spear 50 mm
- SG 11778 Ellipse 50 mm
- SG 11779 Taper 50 mm

## C. WAVE

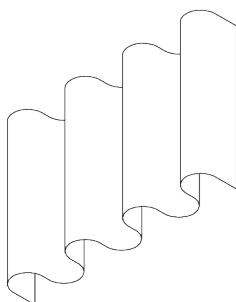



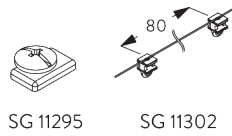

SG 11295

SG 11302

**Composants standards:**

- SG 11295 Vis d'arrêt
- SG 11302 Glisseurs Wave bi-composants 80 mm

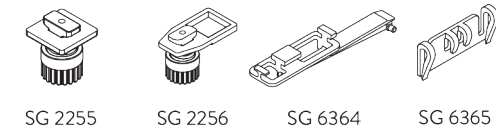

SG 2255

SG 2256

SG 6364

SG 6365

**Composants en option:**

- SG 2255 Frein
- SG 2256 Frein
- SG 6364 Extension Wave
- SG 6365 Crochet Wave
- SG 6366 Chariot Wave pour lance rideau
- SG 10430-34 Lance rideau
- SG 11303 Glisseur Wave bi-composants 60 mm



SG 6366

SG 10430-34

SG 11303

**Composants de rideaux:**

- SG 3582 Crochet
- SG 6349 Ruban Wave transparent
- SG 6363 Ruban à repasser
- SG 10075 Fil à plomb 50 gr/m
- SG 10076 Barre de lestage

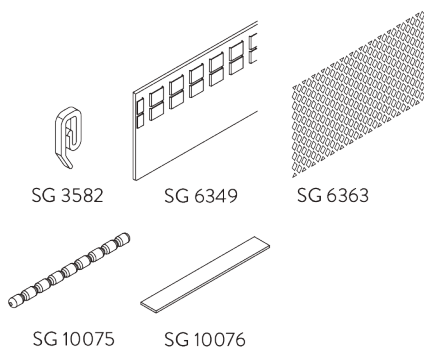

SG 3582

SG 6349

SG 6363

SG 10075

SG 10076

**Paquet rideau Wave - Glisseur Bi-composants (standard)**

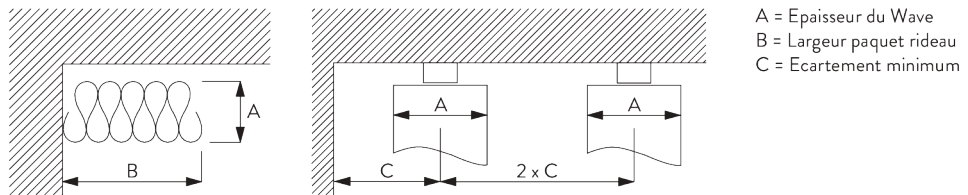

A = Epaisseur du Wave  
 B = Largeur paquet rideau  
 C = Ecartement minimum

Glisseur Bi-composants SG 11302	Nombre de poches entre crochets	Ampleur rideau Approximative	Epaisseur du Wave A	Largeur paquet rideau B*	Ecartement minimum C
80	6	~2.1	140	180 mm par ml de triangle	90
80	7	~2.3	160	180 mm par ml de triangle	100

Glisseur Bi-composants SG 11303	Nombre de poches entre crochets	Ampleur rideau Approximative	Epaisseur du Wave A	Largeur paquet rideau B*	Ecartement minimum C
60	4	~2.1	100	230 mm par ml de triangle	70
60	5	~2.3	120	230 mm par ml de triangle	80

\*Largeur paquet rideau B lors de l'utilisation du bras d'extension SG 6364 augmente de 95 mm par rideau!

# ACCESSOIRES

## A. ACCESSOIRES STANDARDS

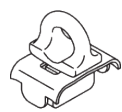

**SG 6065**

Fixateur avec oeillet

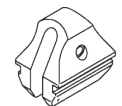

**SG 6086**

Ressort d'arrêt delrin



**SG 6141**

Ecrou fixation



**SG 10492**

Vis M4x8

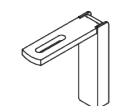

**SG 11206**

Smart Fix 60 mm avec fente

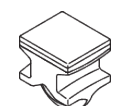

**SG 11305**

Glisseur Bi-composants pour couture directe



**SG 11605**

Embout Flush 50 mm

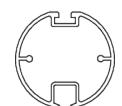

**SG 11609**

Profil

## B. ACCESSOIRES EN OPTION

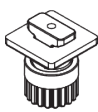

**SG 2255**

Frein

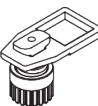

**SG 2256**

Frein



**SG 3012**

Agrafe à coudre



**SG 3582**

Agrafe Delrin



**SG 3599**

Crochet pour galon à froncer



**SG 6057**

Glisseur



**SG 6082**

Glisseur à coudre



**SG 6094**

Rouleur



**SG 6098**

Rouleur

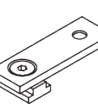

**SG 6151**

Support 3 mm

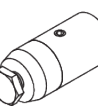

**SG 6175**

Mini suspension

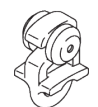

**SG 6283**

Rouleur



**SG 6349**

Ruban Wave transparent



**SG 6363**

Ruban à repasser

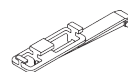

**SG 6364**

Extension

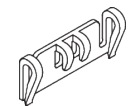

**SG 6365**

Crochet Wave

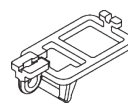

**SG 6366**

Chariot pour lance rideau

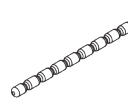

**SG 10075**

Fil à plomb 50 gr/m

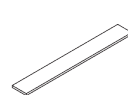

**SG 10076**

Barre de lestage

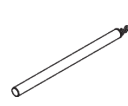

**SG 10430**

Lance rideau aluminium avec crochet, 50cm

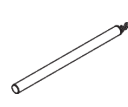

**SG 10431**

Lance rideau aluminium avec crochet, 75 cm

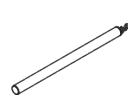

**SG 10432**

Lance rideau aluminium avec crochet, 100 cm

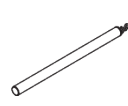

**SG 10433**

Lance rideau aluminium avec crochet, 125 cm

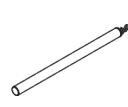

**SG 10434**

Lance rideau aluminium avec crochet, 150 cm

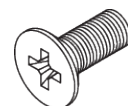

**SG 11127**

Vis M4x10

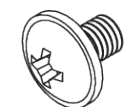

**SG 11131**

Vis M4x6

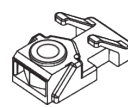

**SG 11148**

Ecrou

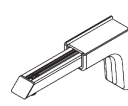

**SG 11154**

Universal Smart Fix 120 mm

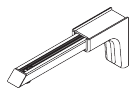

**SG 11155**  
Universal Smart Fix 150 mm



**SG 11156**  
Universal Smart Fix 200 mm

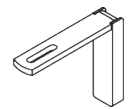

**SG 11207**  
Smart Fix 80 mm avec fente

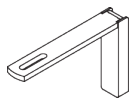

**SG 11208**  
Smart Fix 100 mm avec fente

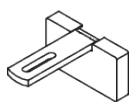

**SG 11216**  
Square Smart Fix 60 mm avec fente

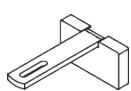

**SG 11217**  
Square Smart Fix 80 mm avec fente

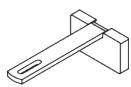

**SG 11218**  
Square Smart Fix 100 mm avec fente

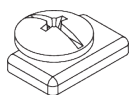

**SG 11295**  
Arrêt

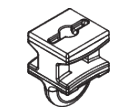

**SG 11300**  
Glisseur Bi-composants



**SG 11301**  
Glisseur Bi-composants en barrette

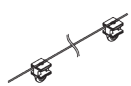

**SG 11302**  
Glisseur Wave Bi-composants 80 mm

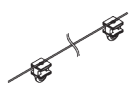

**SG 11303**  
Glisseur Wave Bi-composants 60 mm



**SG 11651**  
Embout Stud 50 mm

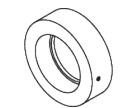

**SG 11652**  
Embout Design 50 mm



**SG 11668**  
Support Top Fix

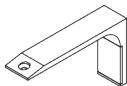

**SG 11669**  
Support désign

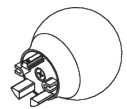

**SG 11776**  
Ball 50 mm

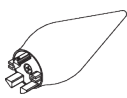

**SG 11777**  
Spear 50 mm



**SG 11778**  
Ellipse 50 mm

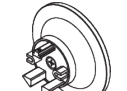

**SG 11779**  
Taper 50 mm

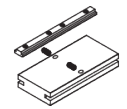

**SG 11783**  
Pont de connexion

## **Les architectes du silence**

**Silent Gliss est le premier fournisseur mondial d'équipements de protection visuelle et solaire d'intérieur de haute qualité. Depuis 1952, l'emploi des technologies les plus récentes ainsi que les efforts inlassables de recherche de précision permettent de mettre au point en Suisse des systèmes de rideaux plus silencieux et simples à utiliser que n'importe quel autre système au monde.**

*Pour répondre aux besoins de nos clients, nous proposons des produits fonctionnels et sans entretien, faits sur mesure. Des conseils techniques d'experts dans le domaine résidentiel et commercial ainsi que des services d'installation et d'assistance complètent notre gamme. Silent Gliss privilégie toujours les solutions sur mesure innovantes, pratiques et durables, d'un design exceptionnel et d'une qualité supérieure.*

### **Silent Gliss AG**

Ostermundigenstrasse 99a  
3006 Bern

**T** +41 32 387 11 11

**F** +41 32 387 11 40

info@silentgliss.ch

**silentgliss.ch**