

SG 7605

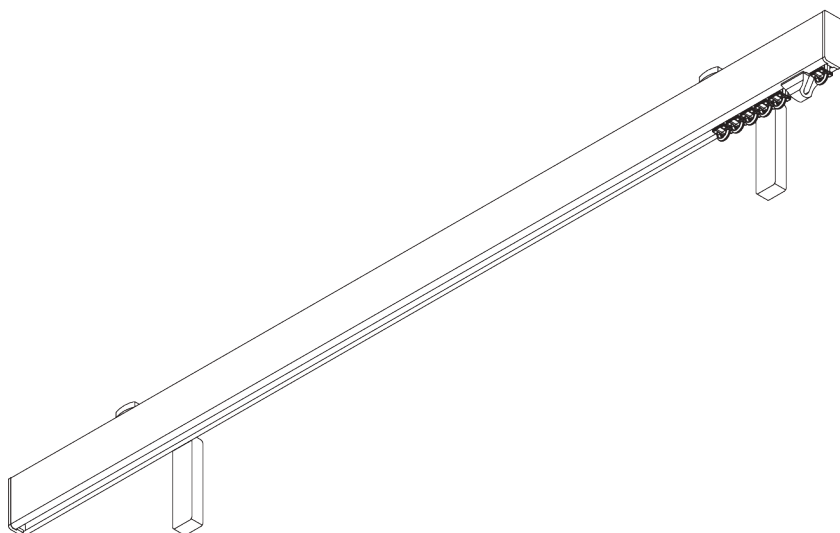
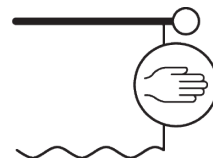

INFORMATION PRODUIT

- **Mode de commande:** Tirage main
- **Gamme:** S - M
- **Installation:** Plafond, murale
- **Couleurs:** Blanc RAL 9016, couleurs spéciales possibles
- **Tissus:** Se référer à la collection tissu Silent Gliss

Caractéristiques:

- Glisseurs Bi-Composants
- Option Glisseurs Wave Bi-Composants
- Couleurs assorties pour embouts et supports
- Cintrable

SPÉCIFICATION SYSTÈME

A. PROFIL

Profil et information de cintrage

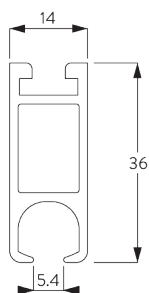

SG 6101

Profil

Rayon:
20 cm, >25 cm

B. PRISE DE MESURE

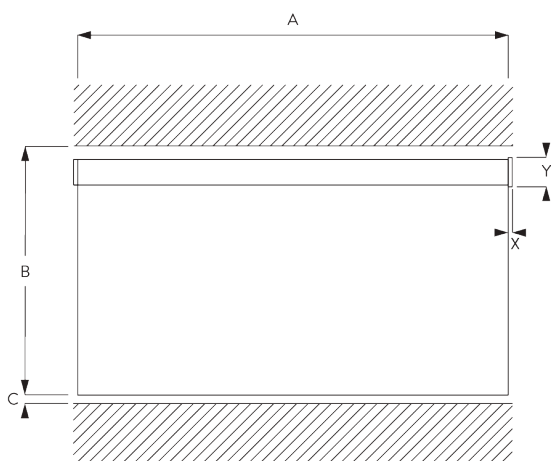

A: Largeur système sans les embouts

B: Hauteur système

C: Distance entre bas du rideau et le sol

X: Largeur des embouts

Y: Hauteur des embouts

Dimensions des embouts

		36 mm	
		X	Y
	SG 11601	2	36
	SG 11611	5	40

INSTALLATION

A. INSTRUCTION DE POSE

Pour des informations détaillées, se référer au site web
Silent Gliss.

Points de fixation

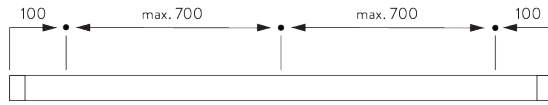

B. FIXATION PLAFOND

Support Top Fix SG 11668

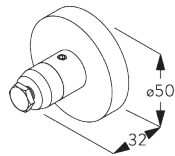
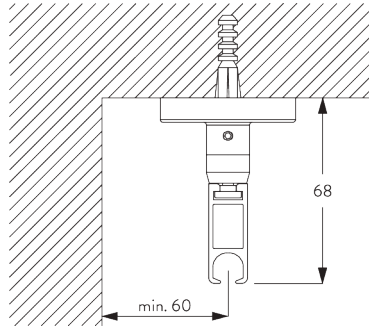

SG 11668
Support Top Fix

Mini suspension SG 6175

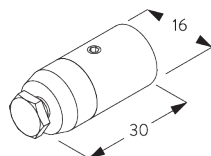
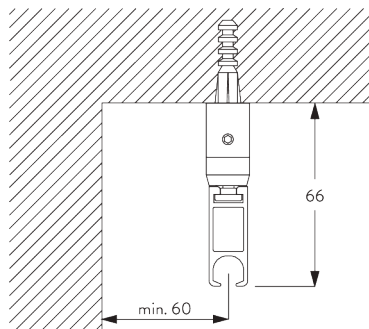

SG 6175
Mini suspension

C. FIXATION MURALE

Smart Fix

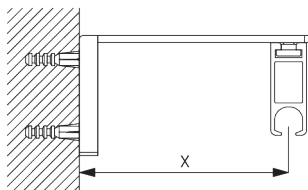

Smart Fix avec fente SG 11206 - SG 11208 et SG 6141:

Vis SG 10492 (M4x10) nécessaire.

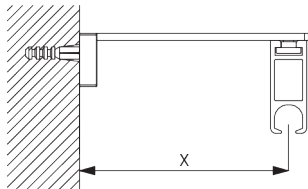

Square Smart Fix avec fente SG 11216 - SG 11218 et SG 6141:

Vis SG 10492 (M4x10) nécessaire.

Smart Fix	X mm
SG 11206 / SG 11216	51
SG 11207 / SG 11217	71
SG 11208 / SG 11218	91

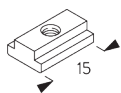

SG 6141

Ecrou fixation



SG 10492

Vis M4x8

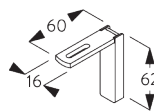

SG 11206

Smart Fix 60 mm avec fente

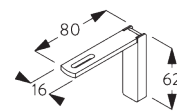

SG 11207

Smart Fix 80 mm avec fente

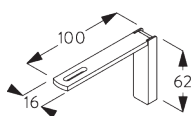

SG 11208

Smart Fix 100 mm avec fente

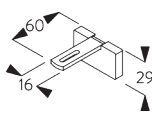

SG 11216

Square Smart Fix 60 mm avec fente

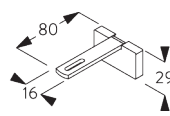

SG 11217

Square Smart Fix 80 mm avec fente

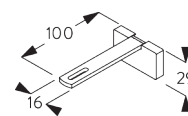

SG 11218

Square Smart Fix 100 mm avec fente

Support design SG 11669

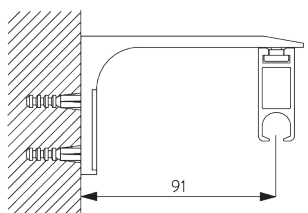

Vis SG 10492 (M4x8) nécessaire.

Recommandé pour les systèmes droits uniquement.

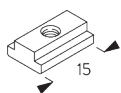

SG 6141

Ecrou fixation



SG 10492

Vis M4x8

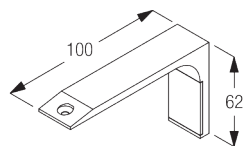

SG 11669

Support design

OPTIONS DÉSIGN & SYSTÈME

A. EMBOUTS



SG 11601



SG 11611

Note:

- Les profils sont fournis en standard avec l'embout Flush SG 11601 (gauche)
- Alternativement, les embouts Stud SG 11611 sont disponibles.

B. WAVE

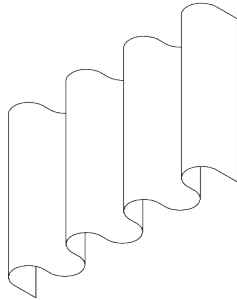

SG 11295

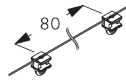

SG 11302

Composants standards:

- SG 11295 Vis d'arrêt
- SG 11302 Glisseurs Wave bi-composants 80 mm



SG 2255



SG 2256

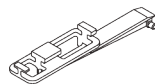

SG 6364



SG 6365

Composants en option (rayon >25 cm):

- SG 2255 Frein
- SG 2256 Frein
- SG 6364 Extension Wave
- SG 6365 Crochet Wave
- SG 6366 Chariot Wave pour lance rideau
- SG 10430-34 Lance rideau
- SG 11303 Glisseur Wave bi-composants 60 mm

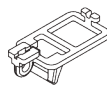

SG 6366

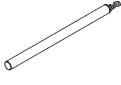

SG 10430-34

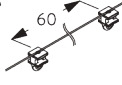

SG 11303

Composants de rideaux:

- SG 3582 Crochet
- SG 6349 Ruban Wave transparent
- SG 6363 Ruban à repasser
- SG 10075 Fil à plomb 50 gr/m
- SG 10076 Barre de lestage



SG 3582

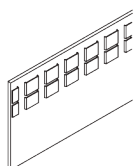

SG 6349

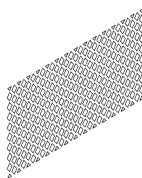

SG 6363



SG 10075



SG 10076

Paquet rideau Wave - Glisseur Bi-composants (standard)

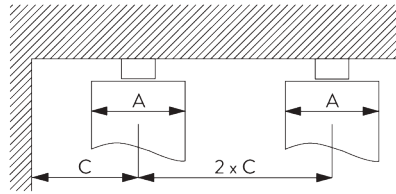
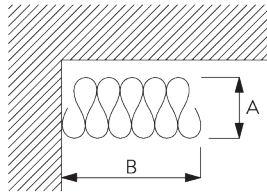

A = Epaisseur du Wave
 B = Largeur paquet rideau
 C = Ecartement minimum





Glisseur Bi-composants SG 11302	Nombre de poches entre crochets	Ampleur rideau Approximative	Epaisseur du Wave A	Largeur paquet rideau B*	Ecartement minimum C
80	6	~2.1	140	180 mm par ml de tringle	90
80	7	~2.3	160	180 mm par ml de tringle	100

Glisseur Bi-composants SG 11303	Nombre de poches entre crochets	Ampleur rideau Approximative	Epaisseur du Wave A	Largeur paquet rideau B*	Ecartement minimum C
60	4	~2.1	100	230 mm par ml de tringle	70
60	5	~2.3	120	230 mm par ml de tringle	80



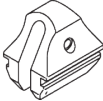

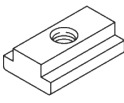
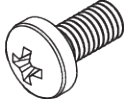
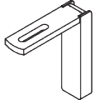

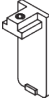



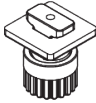
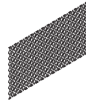
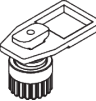
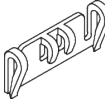
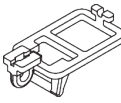

**Largeur paquet rideau B lors de l'utilisation du bras d'extension SG 6364 augmente de 95 mm par rideau!*

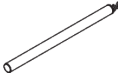
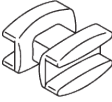
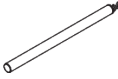
ACCESSOIRES

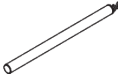
A. ACCESSOIRES STANDARDS

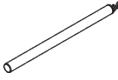
	SG 6065 Fixateur avec oeillet
	SG 6086 Ressort d'arrêt delrin
	SG 6101 Profil
	SG 6141 Ecrou fixation
	SG 10492 Vis M4x8
	SG 11206 Smart Fix 60 mm avec fente
	SG 11305 Glisseur Bi-composants pour couture directe
	SG 11601 Embout Flush 36 mm

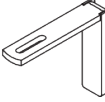
B. ACCESSOIRES EN OPTION

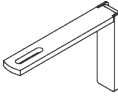
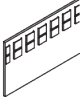
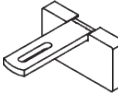
	SG 2255 Frein		SG 6363 Ruban à repasser
	SG 2256 Frein		SG 6364 Extension
	SG 3012 Agrafe à coudre		SG 6365 Crochet Wave
	SG 3582 Agrafe Delrin		SG 6366 Chariot pour lance rideau
	SG 3599 Crochet pour galon à froncer		SG 10075 Fil à plomb 50 gr/m
	SG 6053 Ressort d'arrêt		SG 10076 Barre de lestage
	SG 6057 Glisseur		SG 10430 Lance rideau aluminium avec crochet, 50cm
	SG 6082 Glisseur à coudre		SG 10431 Lance rideau aluminium avec crochet, 75 cm
	SG 6094 Rouleur		SG 10432 Lance rideau aluminium avec crochet, 100 cm
	SG 6098 Rouleur		SG 10433 Lance rideau aluminium avec crochet, 125 cm
	SG 6112 Pont de connexion		SG 10434 Lance rideau aluminium avec crochet, 150 cm
	SG 6175 Mini suspension		SG 11207 Smart Fix 80 mm avec fente
	SG 6283 Rouleur		SG 11208 Smart Fix 100 mm avec fente
	SG 6349 Ruban Wave transparent		SG 11216 Square Smart Fix 60 mm avec fente

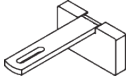

SG 11217

Square Smart Fix 80 mm avec fente

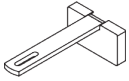

SG 11218

Square Smart Fix 100 mm avec fente

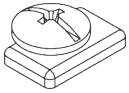

SG 11295

Arrêt



SG 11300

Glisseur Bi-composants



SG 11301

Glisseur Bi-composants en barrette

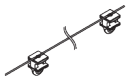

SG 11302

Glisseur Wave Bi-composants 80 mm

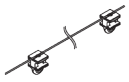

SG 11303

Glisseur Wave Bi-composants 60 mm

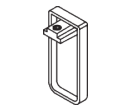

SG 11611

Embout Stud 36 mm

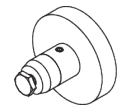

SG 11668

Support Top Fix

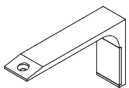

SG 11669

Support design
