

# SG 7610

---

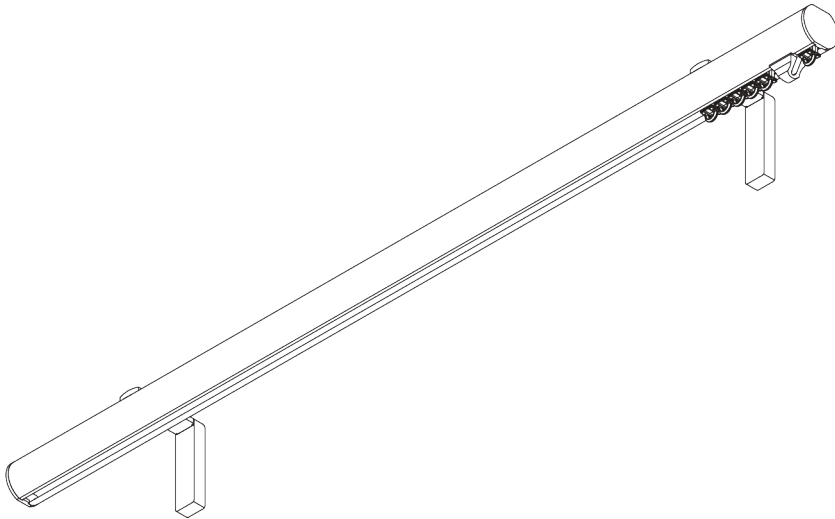
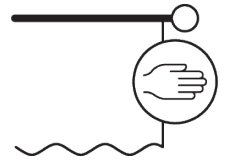

## PRODUCT INFORMATION

- **Bedienung:** Hand
- **Grösse:** S - M
- **Montage:** Decke, Wand
- **Farben:** weiss RAL 9016, verschiedene Farben / Ausführungen
- **Stoffe:** siehe Silent Gliss Stoffkollektion

### **Merkmale:**

- 2-Komponenten-Gleiter-Technologie (2C)
- Wave (2C)
- Passende Enddeckel und Träger / Trägerabdeckungen
- Auswahl an dekorativen Endstücken
- Biegsam

# SYSTEMSPEZIFIKATIONEN

## A. PROFIL

Profil- und  
Biegeinformationen

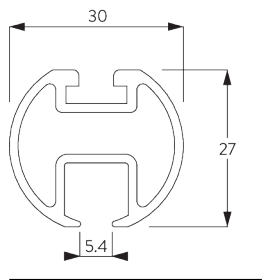

**SG 6103p**

Profil

✓ Radius:  
>25 cm

## B. MASSAUFNAHME

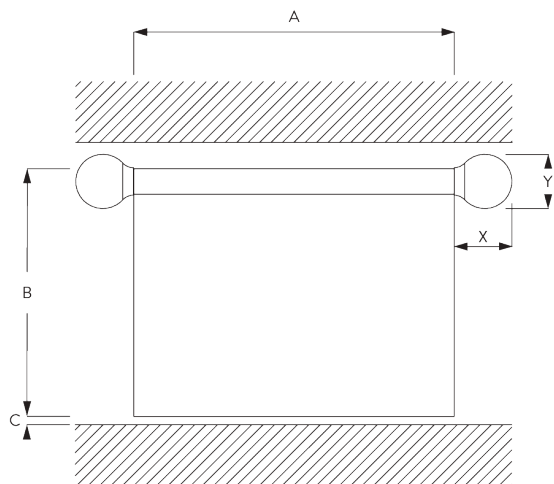

A: Systembreite ohne Endstücke







B: Systemhöhe

C: Abstand zwischen Boden und Behang

X: Endstückbreite

Y: Endstückhöhe

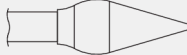
## Endstückmasse

		30 mm	
		X	Y
	SG 11603	2	30
	SG 11631	10	34
	SG 11632	18	50
	SG 11746	64	60
	SG 11747	116	48
	SG 11748	26	90
	SG 11749	20	60

# MONTAGE

## A. MONTAGE- INFORMATIONEN

*Detaillierte Montageinformationen siehe  
Silent Gliss Website*

### Montagepunkte

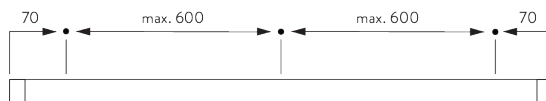

## B. DECKEN- MONTAGE

### Top Fix Träger SG 11668

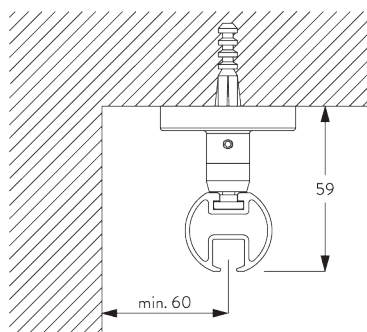



**SG 11668**  
Top Fix Träger

**Mini Hänger SG 6175**

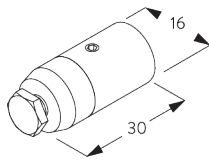
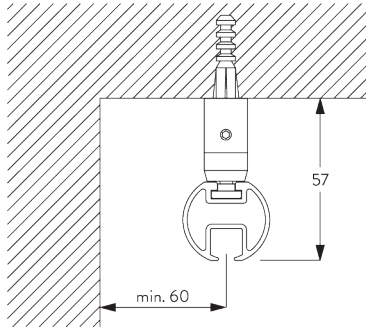

**SG 6175**  
Mini Hänger

**C. WANDMONTAGE**

**Smart Fix**

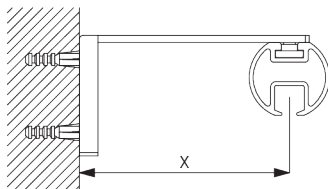

**Smart Fix mit Langloch SG 11206 - SG 11208 und SG 6141:**

Benötigt Schraube SG 10492 (M4x8).

Smart Fix	X mm
SG 11206 / SG 11216	51
SG 11207 / SG 11217	71
SG 11208 / SG 11218	91

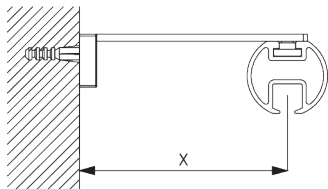

**Square Smart Fix mit Langloch SG 11216 - SG 11218 und SG 6141:**

Benötigt Schraube SG 10492 (M4x8).

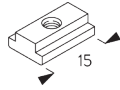

**SG 6141**  
Klemmstück



**SG 10492**  
Linsenschraube M4x8

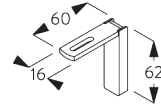

**SG 11206**  
Smart Fix 60 mm mit  
Langloch

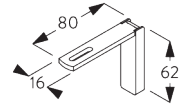

**SG 11207**  
Smart Fix 80 mm mit  
Langloch

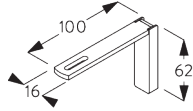

**SG 11208**  
Smart Fix 100 mm mit  
Langloch

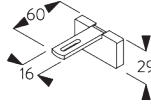

**SG 11216**  
Square Smart Fix 60 mm mit  
Langloch

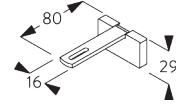

**SG 11217**  
Square Smart Fix 80 mm mit  
Langloch

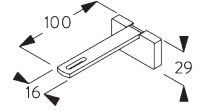

**SG 11218**  
Square Smart Fix 100 mm mit  
Langloch

## Designträger SG 11669

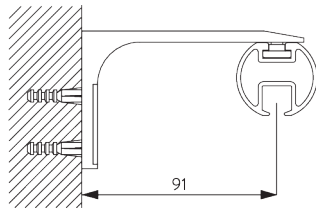

Benötigt Schraube SG 10492 (M4x8).  
Nur für gerade Systeme empfohlen.

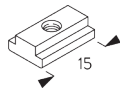

**SG 6141**  
Klemmstück



**SG 10492**  
Linsenschraube M4x8

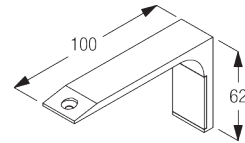

**SG 11669**  
Designträger

# DESIGN- & SYSTEMOPTIONEN

## A. ENDECKEL



SG 11603



SG 11631



SG 11632

Enddeckel:

- SG 11603 Enddeckel bündig 30 mm
- SG 11631 Enddeckel Classic 30 mm
- SG 11632 Enddeckel Design 30 mm

Bemerkung:

- Ohne Endstücke werden die Systeme standardmäßig mit bündigen Enddeckel SG 11603 (links) geliefert.
- Alternativ können die Enddeckel Classic SG 11631 gewählt werden.

## B. ENDSTÜCKE

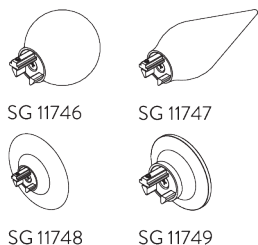

Endstücke sind dekorative Elemente, die am Ende des Profils angebracht werden:

- SG 11746 Kugel 30 mm
- SG 11747 Speer 30 mm
- SG 11748 Ellipse 30 mm
- SG 11749 Kegel 30 mm

## C. WAVE

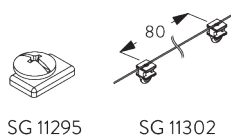
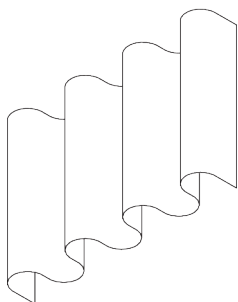

Standard Komponenten:

- SG 11295 Feststeller
- SG 11302 Wave-2C-Gleiterkordel 80 mm

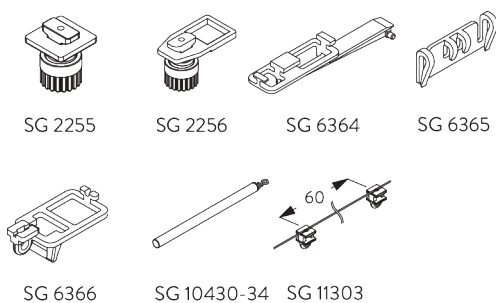

Optionale Komponenten:

- SG 2255 Bremse
- SG 2256 Bremse
- SG 6364 Wave Verlängerung
- SG 6365 Wave Hänger
- SG 6366 Wave Träger für Schleuderstab
- SG 10430-34 Schleuderstab
- SG 11303 Wave-2C-Gleiterkordel 60 mm

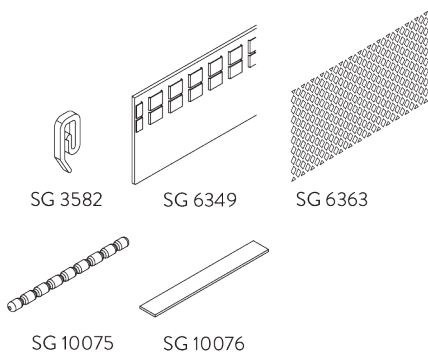

Vorhang Komponenten:

- SG 3582 Haken
- SG 6349 Wave Vorhangband
- SG 6363 Wave Bügelband
- SG 10075 Bleischnur 50 gr/m
- SG 10076 Beschwerung Seitensaum

Wave stack depth - 2C glider cord (standard components)

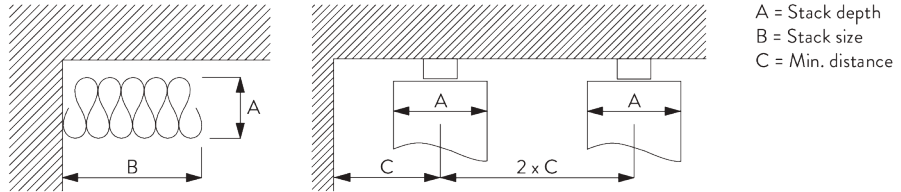

2C Glider cord SG 11302	Pockets between hooks	Approx. curtain fullness	Stack depth A	Stack size B*	Min distance C
80	6	~2.1	140	180 per metre of track	90
80	7	~2.3	160	180 per metre of track	100

2C Glider cord SG 11303	Pockets between hooks	Approx. curtain fullness	Stack depth A	Stack size B*	Min distance C
60	4	~2.1	100	230 per metre of track	70
60	5	~2.3	120	230 per metre of track	80

\*Paketgröße B vergrößert sich um 95 mm pro Vorhangpaket bei Verwendung des optionalen Verlängerungsarms SG 6364!

# KOMPONENTEN

## A. STANDARD KOMPONENTEN

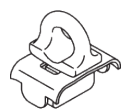

**SG 6065**

Feststeller

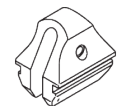

**SG 6086**

Verschlussfeder



**SG 6103p**

Profil

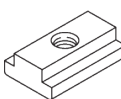

**SG 6141**

Klemmstück



**SG 10492**

Linsenschraube M4x8

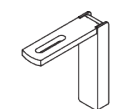

**SG 11206**

Smart Fix 60 mm mit Langloch

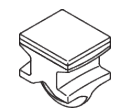

**SG 11305**

2C-Gleiter für direktes Annähen

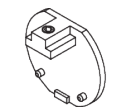

**SG 11603**

Enddeckel bündig 30 mm

## B. OPTIONALE KOMPONENTEN

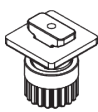

**SG 2255**

Bremse

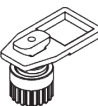

**SG 2256**

Bremse



**SG 3012**

Haken



**SG 3582**

Haken



**SG 3599**

Haken



**SG 6057**

Gleiter



**SG 6082**

Gleiter



**SG 6094**

Roller



**SG 6098**

Roller

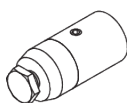

**SG 6175**

Mini Hänger



**SG 6283**

Roller



**SG 6349**

Wave Vorhangband

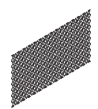

**SG 6363**

Wave Bügelband

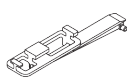

**SG 6364**

Wave Verlängerungsarm

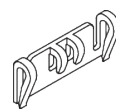

**SG 6365**

Wave Hänger

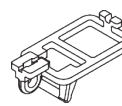

**SG 6366**

Wave Mitnehmer für Schleuderstab

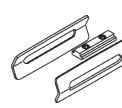

**SG 6635**

Verbindungsset



**SG 10075**

Bleischnur 50 gr/m

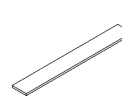

**SG 10076**

Beschwerung Seitensaum

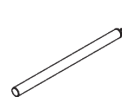

**SG 10430**

Schleuderstab 50 cm

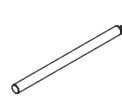

**SG 10431**

Schleuderstab 75 cm

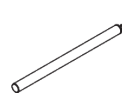

**SG 10432**

Schleuderstab 100 cm

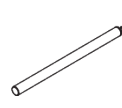

**SG 10433**

Schleuderstab 125 cm

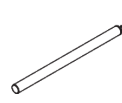

**SG 10434**

Schleuderstab 150 cm

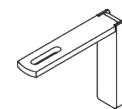

**SG 11207**

Smart Fix 80 mm mit Langloch

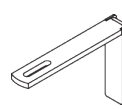

**SG 11208**

Smart Fix 100 mm mit Langloch

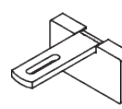

**SG 11216**

Square Smart Fix 60 mm mit Langloch

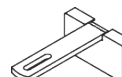

**SG 11217**

Square Smart Fix 80 mm mit Langloch



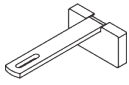

**SG 11218**

Square Smart Fix 100 mm mit  
Langloch

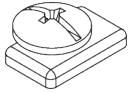

**SG 11295**

Feststeller

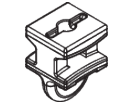

**SG 11300**

2C-Gleiter



**SG 11301**

2C-Gleiter am Strip

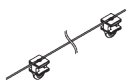

**SG 11302**

Wave-2C-Gleiterkordel 80 mm

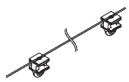

**SG 11303**

Wave-2C-Gleiterkordel 60 mm

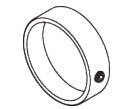

**SG 11631**

Enddeckel Classic 30 mm

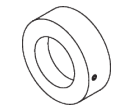

**SG 11632**

Enddeckel Design 30 mm

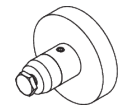

**SG 11668**

Top Fix Träger

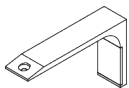

**SG 11669**

Designträger

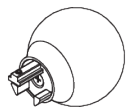

**SG 11746**

Kugel 30 mm



**SG 11747**

Speer 30 mm

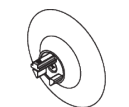

**SG 11748**

Ellipse 30 mm



**SG 11749**

Kegel 30 mm





