

# SG 4910

---

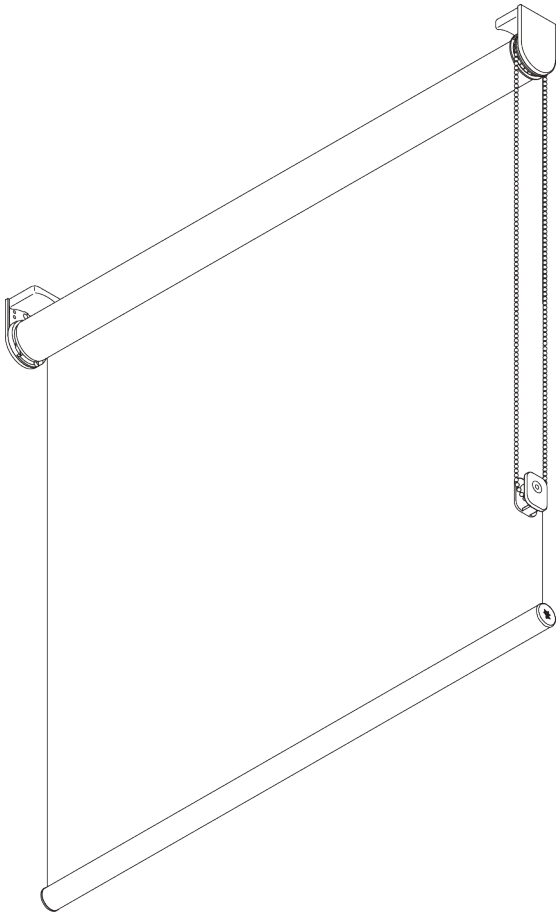
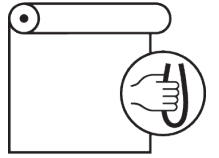

## PRODUKTINFORMATIONEN

- **Bedienung:** Kette
- **Grösse:** S - M
- **Montage:** Decke, Wand, Nische
- **Farben:** weiss RAL 9016, grau RAL 7035, schwarz RAL 9005; Sonderfarben möglich
- **Stoffe:** siehe Silent Gliss Stoffkollektion

### **Merkmale:**

- Federunterstütze, leichtgängige Bedienung
- 1:1 Kettenantrieb
- Rostfreie Stahlkugellkette
- Klick-in-Träger, Fascia, Box, Montageprofil
- Einstellbarer End-Stop

04/2024/V3

# SYSTEMSPEZIFIKATIONEN

## A. MASSE / GEWICHT

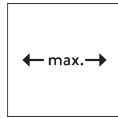

2.4 m

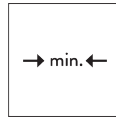

25 cm\*,  
Fascia / Box: 60 cm  
\*25 - 60 cm nur mit  
Montageprofil SG 10534

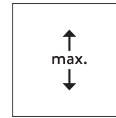

3 m



7.2 m<sup>2</sup>



3 kg

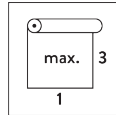

Empfohlenes Breiten- /  
Höhenverhältnis  
max. 1:3

## Maximale Systemhöhen

### Wandmontage (fensterseitig abrollend)

Stoffdicke	mm	0.15	0.20	0.25	0.30	0.35	0.40	0.45	0.50	0.55	0.60	0.65	0.70	0.75	0.80
Max. Systemhöhe	cm	300	300	300	300	300	300	300	300	300	290	270	250	230	220

### Deckenmontage / Wandmontage (raumseitig abrollend)

Stoffdicke	mm	0.15	0.20	0.25	0.30	0.35	0.40	0.45	0.50	0.55	0.60	0.65	0.70	0.75	0.80
Max. Systemhöhe	cm	300	300	300	300	300	300	300	300	300	300	300	300	300	280

## B. PROFIL

### Profilinformationen

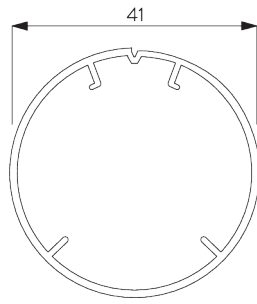

**SG 10531**  
Rohr ø 41 mm



**SG 10760**  
Beschwerung

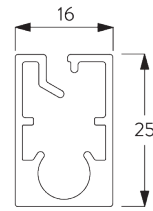

**SG 10770**  
Beschwerung

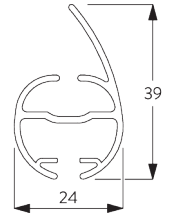

**SG 4903**  
Beschwerung

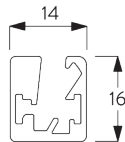

**SG 11442**  
Beschwerung

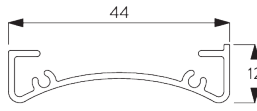

**SG 10534**  
Montageprofil

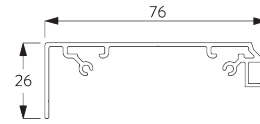

**SG 11430**  
Montageprofil Fascia 73 mm

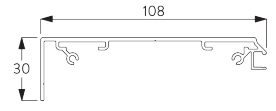

**SG 11530**  
Montageprofil Fascia 110 mm

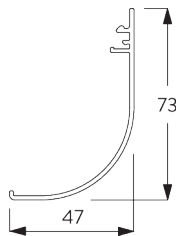

**SG 11431**  
Fascia rund 73 mm

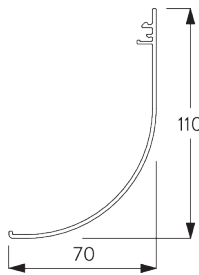

**SG 11531**  
Fascia rund 110 mm

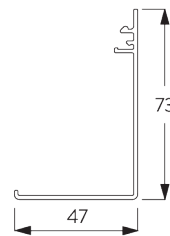

**SG 11432**  
Fascia eckig 73 mm

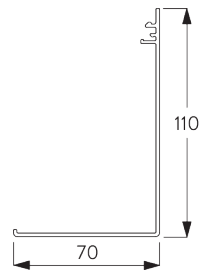

**SG 11532**  
Fascia eckig 110 mm

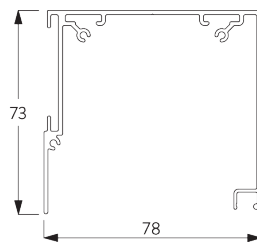

**SG 11433**  
Box 73 mm

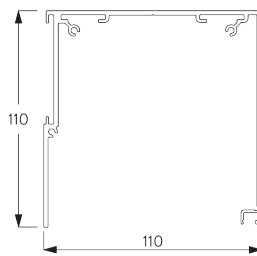

**SG 11533**  
Box 110 mm

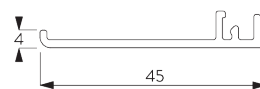

**SG 11434**  
Box Deckel 73 mm

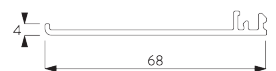

**SG 11534**  
Box Deckel 110 mm

## C. MASSAUFNAHME

inkl. Trägerabdeckung

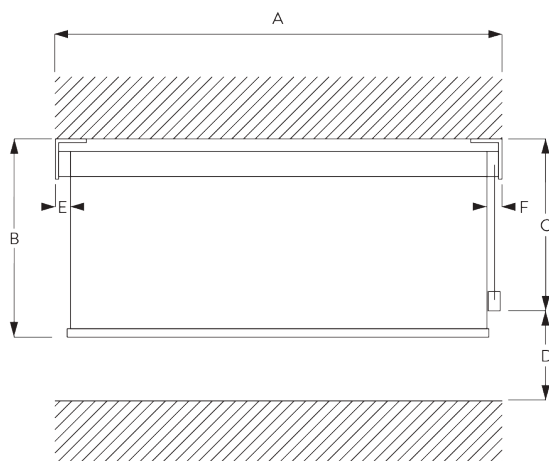

- A: Systembreite
- B: Systemhöhe
- C: Kettenhöhe
- D: Kindersicherung SG 10731 min. 150 cm über Boden
- E: Lichtspalt: 13 mm
- F: Lichtspalt Antriebsseite: 18 mm

Bemerkung:  
Alle Masse beinhalten 2 mm für die Trägerabdeckung pro Seite!

## Fascia / Box

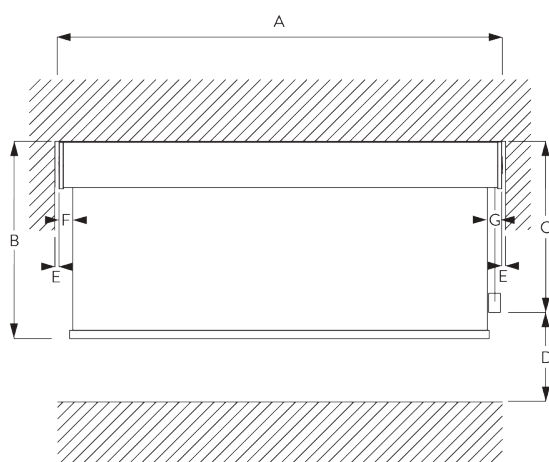

- A: Systembreite
- B: Systemhöhe
- C: Kettenhöhe
- D: Kindersicherung SG 10731 min. 150 cm über Boden
- E: Spalt: min. 10 mm (wenn Abdeckung verwendet wird)
- F: Lichtspalt: 15 mm
- G: Lichtspalt Antriebsseite: 21 mm

# MONTAGE

## A. MONTAGE- INFORMATIONEN

Detaillierte Montageinformationen siehe  
Silent Gliss Website

### Montagepunkte



Träger (Wand / Decke)

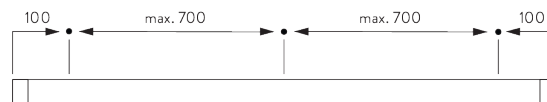

Fascia / Box & Montageprofil SG 10534 (Wand / Decke)

**B. DECKEN-  
MONTAGE**

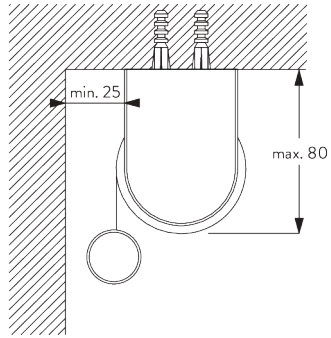

**Träger**

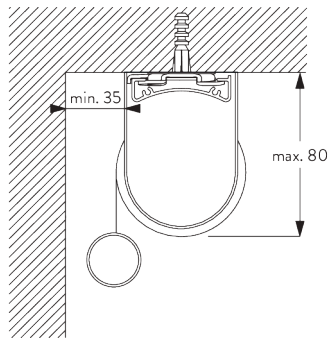

**Montageprofil SG 10534 und Spanner SG 3033  
oder SG 3044**

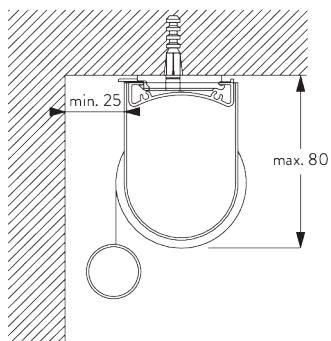

**Montageprofil SG 10534 und Klickträger SG 10539**

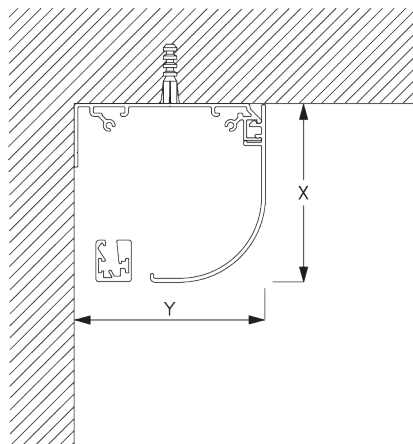

**Fascia rund**

X = Fascia S 73 mm / Fascia L 110 mm

Y = Fascia S 78 mm / Fascia L 110 mm

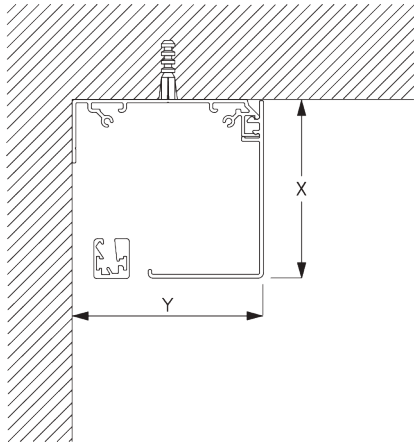

**Fascia eckig**

X = Fascia S 73 mm / Fascia L 110 mm

Y = Fascia S 78 mm / Fascia L 110 mm

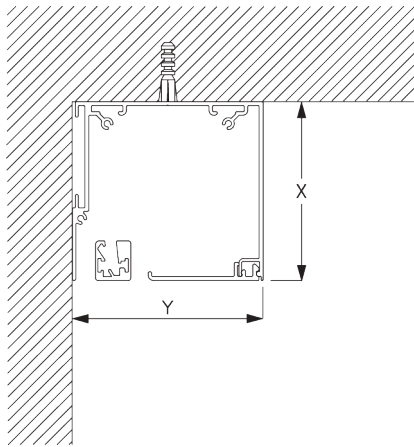

**Box**

X = Box S 73 mm / Box L 110 mm

Y = Box S 78 mm / Box L 110 mm

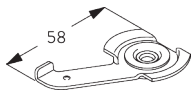

**SG 3033**

Spanner

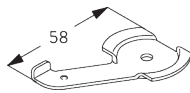

**SG 3044**

Spanner

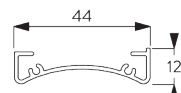

**SG 10534**

Montageprofil

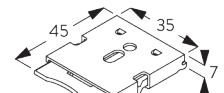

**SG 10539**

Klickträger

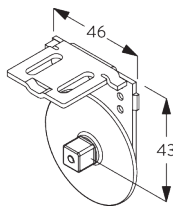

**SG 10542**

Träger

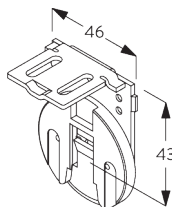

**SG 10543**

Träger



**SG 10574**

Trägerabdeckung

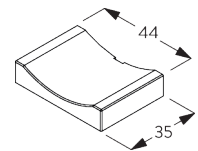

**SG 10575**

Trägerabdeckung

## C. WANDMONTAGE

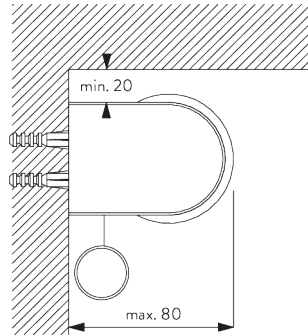

**Träger**

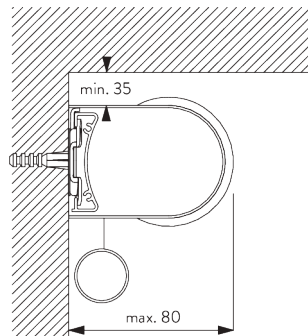

**Montageprofil SG 10534 und Spanner SG 3033  
oder SG 3044**

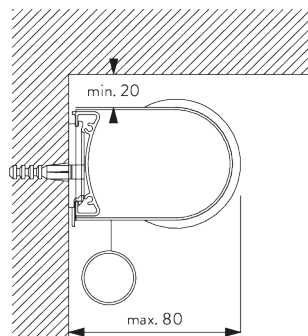

**Montageprofil SG 10534 und Klickträger SG 10539**

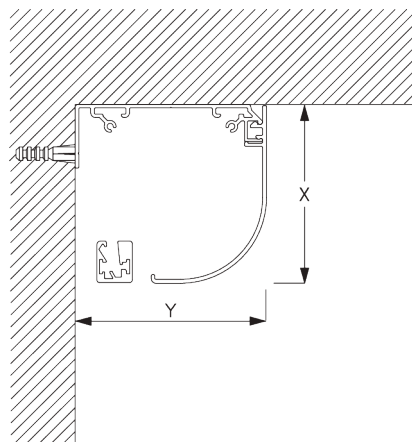

**Fascia rund**

X = Fascia S 73 mm / Fascia L 110 mm

Y = Fascia S 78 mm / Fascia L 110 mm

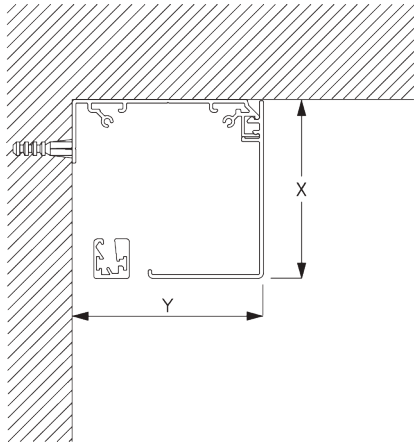

**Fascia eckig**

X = Fascia S 73 mm / Fascia L 110 mm

Y = Fascia S 78 mm / Fascia L 110 mm

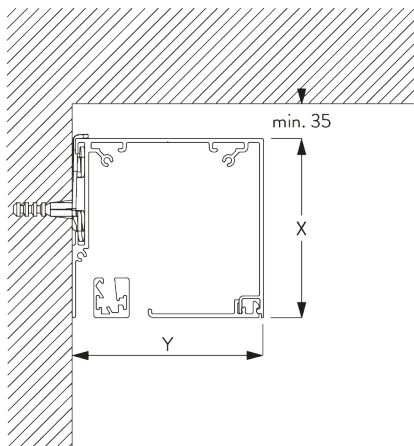

**Box S und Spanner SG 3044 / Box L und Spanner SG 11180**

X = Box S 73 mm / Box L 110 mm

Y = Box S 78 mm / Box L 110 mm

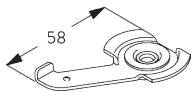

**SG 3033**

Spanner

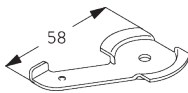

**SG 3044**

Spanner

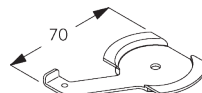

**SG 11180**

Spanner

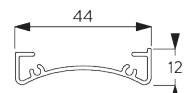

**SG 10534**

Montageprofil

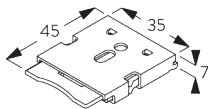

**SG 10539**

Klickträger

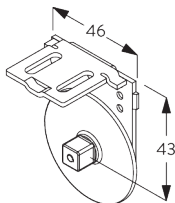

**SG 10542**

Träger

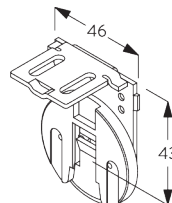

**SG 10543**

Träger



**SG 10574**

Trägerabdeckung



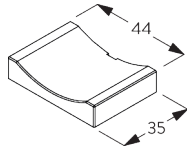

**SG 10575**

Trägerabdeckung

**D. NISCHEN-  
MONTAGE**

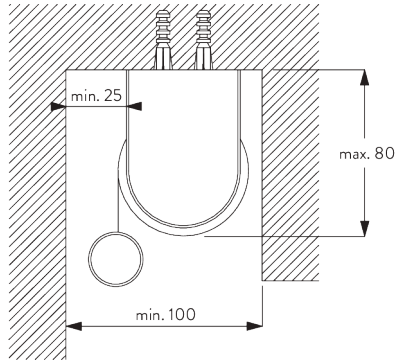

**Träger**

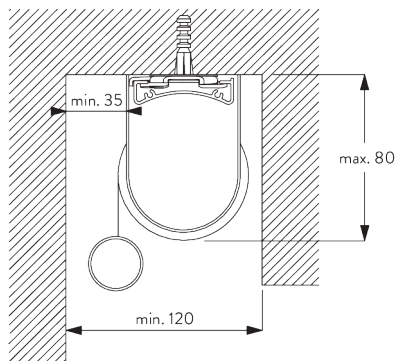

**Montageprofil SG 10534 und Spanner SG 3033  
oder SG 3044**

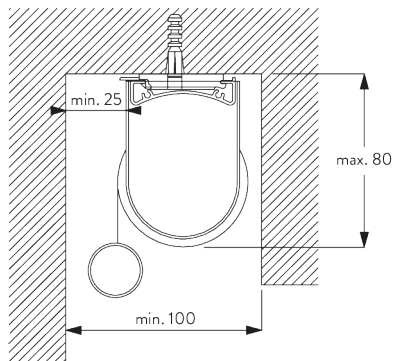

**Montageprofil SG 10534 und Klickträger SG 10539**

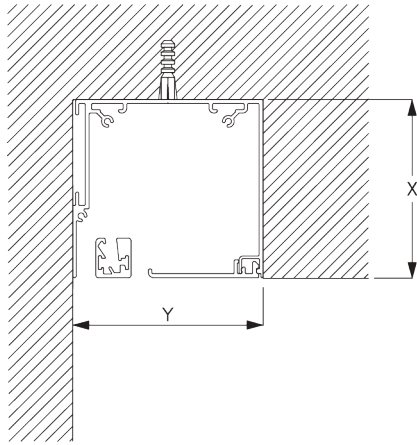

**Box**

X = Box S 73 mm / Box L 110 mm

Y = Box S min. 79 mm / Box L min. 111 mm

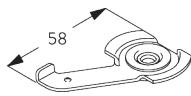

**SG 3033**

Spanner

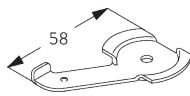

**SG 3044**

Spanner

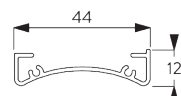

**SG 10534**

Montageprofil

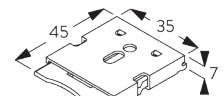

**SG 10539**

Klickträger

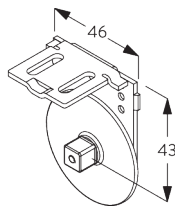

**SG 10542**

Träger

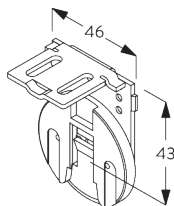

**SG 10543**

Träger



**SG 10574**

Trägerabdeckung

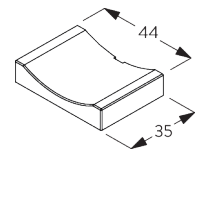

**SG 10575**

Trägerabdeckung

**E. SEITLICHE  
VERSpannung**

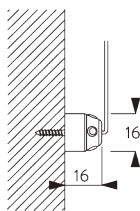
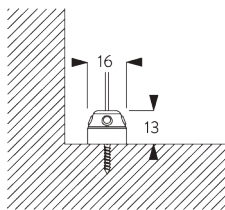

**Einzelssystem**

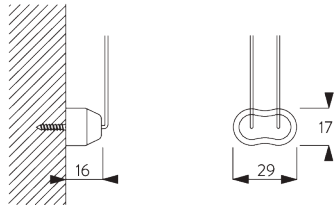
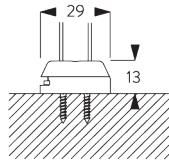

**Seite-an-Seite Montage**

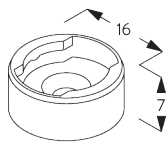

**SG 8235**  
Halter Seitenführung kurz

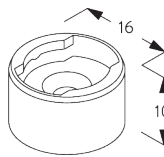

**SG 8236**  
Halter Seitenführung lang

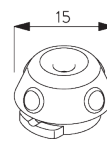

**SG 8237**  
Halter Seitenführung

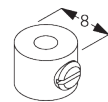

**SG 8249**  
Stelling Seitenführung

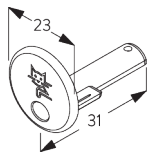

**SG 10762**  
Enddeckel Seitenführung

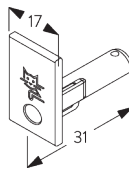

**SG 10772**  
Enddeckel Seitenführung

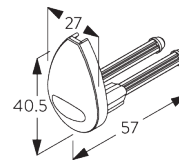

**SG 4944**  
Enddeckel

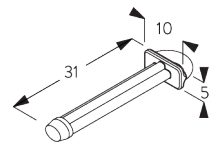

**SG 10641**  
Öse Seitenführung

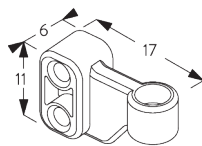

**SG 10642**  
Drahthalter Seitenführung

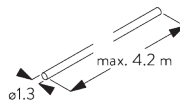

**SG 10643**  
Draht Seitenführung Ø 1.3  
mm x 4.2 m

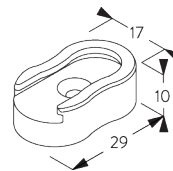

**SG 10669**  
Doppelhalter lang  
Seitenführung lang

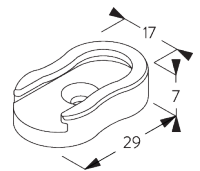

**SG 10673**  
Doppelhalter kurz  
Seitenführung kurz

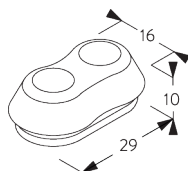

**SG 10701**  
Doppelhalter Seitenführung

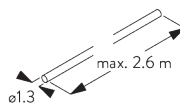

**SG 10706**  
Draht Seitenführung ø 1.3  
mm x 2.6 m

# SYSTEMOPTIONEN

## A. ABROLL- RICHTUNG

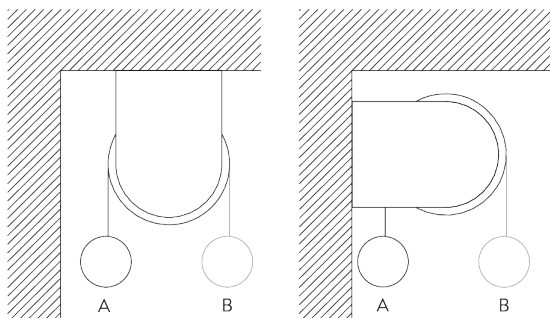

A: Fensterseitiges Stoffabrollen (Standard)

B: Raumseitiges Stoffabrollen (Option)

## B. MONTAGEPROFIL

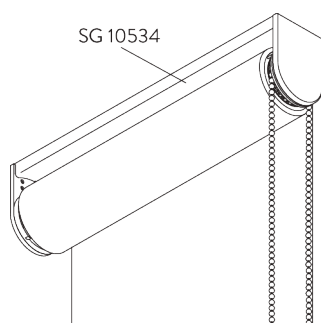

## C. EINSTELLBARER END-STOP

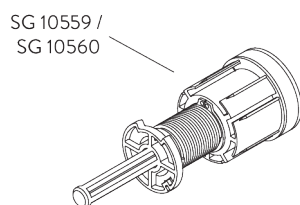

Einstellung von oberer oder unterer Endposition.

## D. SEITLICHE VERSpannung

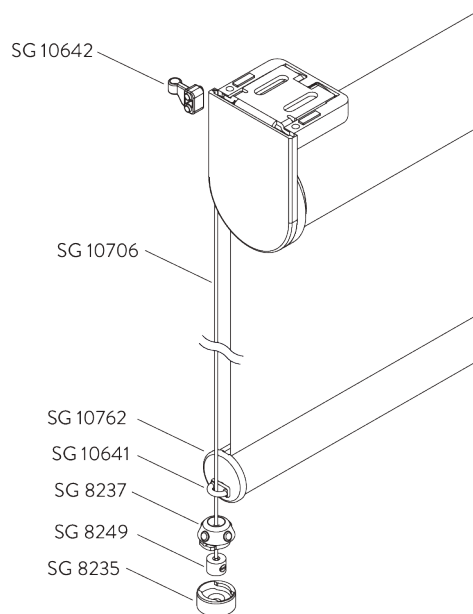

### Zubehör:

- 2x SG 8235 Halter Seitenführung kurz
- 2x SG 8237 Halter Seitenführung
- 2x SG 8249 Stelling Seitenführung
- 2x SG 10762 Enddeckel rund Seitenführung
- 2x SG 10641 Öse Seitenführung
- 2x SG 10642 Drahthalter Seitenführung
- 2x SG 10706 Draht Seitenführung  $\varnothing$  1.3 mm x 2.6 m

### Optionales Zubehör:

- 2x SG 8236 Halter Seitenführung lang
- 2x SG 10772 Enddeckel rechteckig Seitenführung
- 2x SG 10643 Draht Seitenführung  $\varnothing$  1.3 mm x 4.2 m
- 1x SG 10669 Doppelhalter lang Seitenführung
- 1x SG 10673 Doppelhalter kurz Seitenführung
- 1x SG 10701 Doppelhalter Seitenführung

### Bemerkung:

- Bei Verspannung vergrößert sich der Lichtspalt
- Bis 15° Neigung von der Vertikalen

## E. SEITE-AN-SEITE MONTAGE

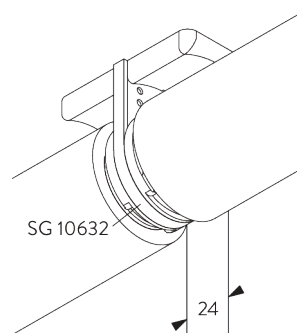

### Zubehör:

- 1x SG 10632 Trägerabdeckung

## F. KINDER- SICHERUNG

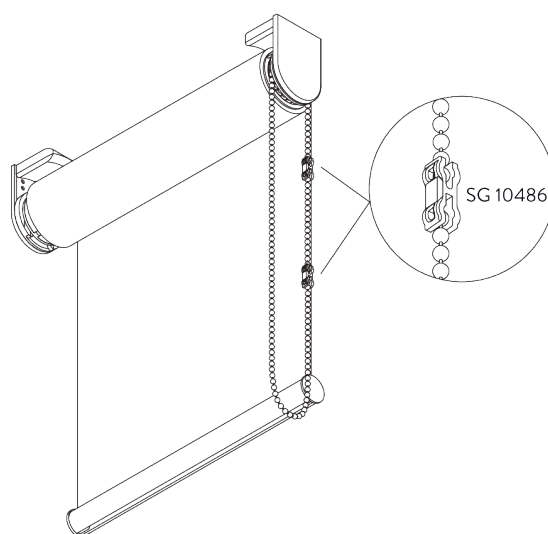

Der Kettenverbinder SG 10486 öffnet sich bei 6 kg Zugbelastung.

### Bemerkung:

- Die Kette muss mindestens 60 cm über dem Boden enden.

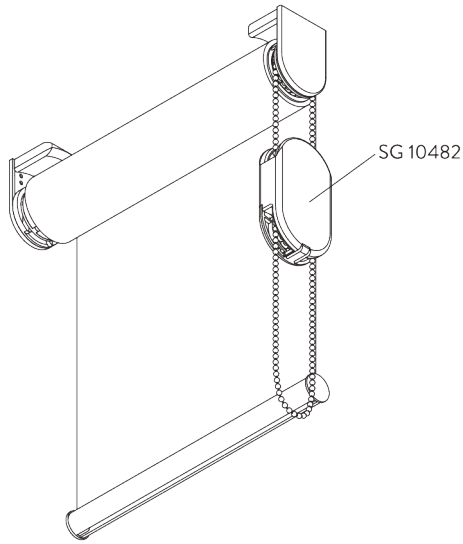

Die Kindersicherung SG 10482 öffnet sich bei 6 kg Zugbelastung.

Bemerkung:

- Die Kette muss mindestens 60 cm über dem Boden enden.

## G. FASCIA / BOX

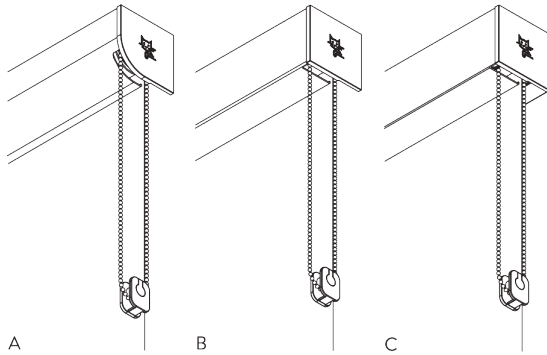

A: Fascia rund  
B: Fascia eckig  
C: Box

Größen:

- S: 78 x 73 mm
- L: 110 x 110 mm

Bemerkung:

- Nur anwendbar mit Beschwerung SG 11442

# KOMPONENTEN

## A. STANDARD KOMPONENTEN



**SG 4226**  
Doppelklebeband 30 mm



**SG 10530**  
Kugelliste Ø 4 mm Stahl rostfrei

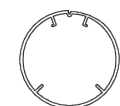

**SG 10531**  
Rohr ø 41 mm



**SG 10542**  
Träger

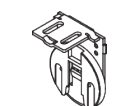

**SG 10543**  
Träger



**SG 10547**  
Federset C links, 641 mm

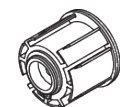

**SG 10556**  
Rohradapter



**SG 10574**  
Trägerabdeckung

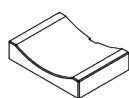

**SG 10575**  
Trägerabdeckung



**SG 10668**  
PVC Streifen 10 mm



**SG 10731**  
Kindersicherheitshalterset



**SG 10760**  
Beschwerung



**SG 10761**  
Enddeckel



**SG 3033**  
Spanner



**SG 3044**  
Spanner



**SG 4903**  
Beschwerung



**SG 8235**  
Halter Seitenführung kurz

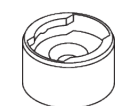

**SG 8236**  
Halter Seitenführung lang



**SG 8237**  
Halter Seitenführung

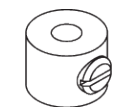

**SG 8249**  
Stellring Seitenführung

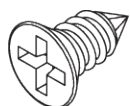

**SG 10139**  
Senkschraube 2.9x6.5

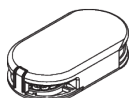

**SG 10482**  
Kindersicherheitsset Stahlkette ø 4.0 mm

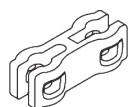

**SG 10486**  
Kindersicherheitskettenbruchset

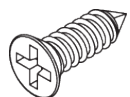

**SG 10498**  
Senkschraube 2.9x9.5



**SG 10534**  
Montageprofil

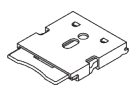

**SG 10539**  
Klickträger



**SG 10545**  
Federset A links, 420 mm

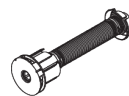

**SG 10546**  
Federset B links, 487 mm



**SG 10548**  
Federset D links, 721 mm

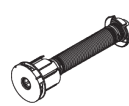

**SG 10549**  
Federset E links, 824 mm

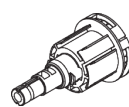

**SG 10550**  
Kettenantrieb

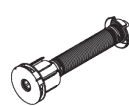

**SG 10551**  
Federset A rechts, 420 mm

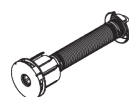

**SG 10552**  
Federset B rechts, 487 mm

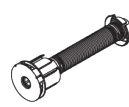

**SG 10553**  
Federset C rechts, 641 mm

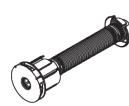

**SG 10554**  
Federset D rechts, 721 mm

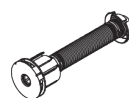

**SG 10555**  
Federset E rechts, 824 mm

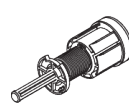

**SG 10559**  
Endstopp links

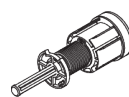

**SG 10560**  
Endstopp rechts





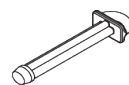







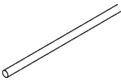
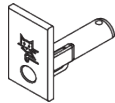
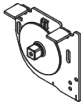





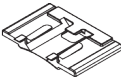
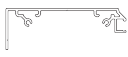







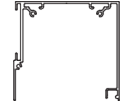

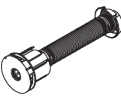

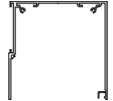



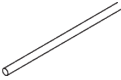

**SG 10632**  
Abdeckung Verbindungsträger

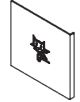

**SG 10641**  
Öse Seitenführung

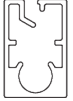

**SG 10642**  
Drahthalter Seitenführung

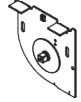
	<b>SG 10643</b> Draht Seitenführung Ø 1.3 mm x 4.2 m		<b>SG 10772</b> Enddeckel Seitenführung		<b>SG 11446</b> Träger links 73 mm
	<b>SG 10669</b> Doppelhalter lang Seitenführung lang		<b>SG 11178</b> Enddeckel		<b>SG 11447</b> Träger rechts 73 mm
	<b>SG 10673</b> Doppelhalter kurz Seitenführung kurz		<b>SG 11180</b> Spanner		<b>SG 11448</b> Träger links 73 mm
	<b>SG 10690</b> Distanzhalter		<b>SG 11430</b> Montageprofil Fascia 73 mm		<b>SG 11449</b> Träger rechts 73 mm
	<b>SG 10697</b> Feder set F, 921 mm		<b>SG 11431</b> Fascia rund 73 mm		<b>SG 11530</b> Montageprofil Fascia 110 mm
	<b>SG 10698</b> Feder set G, 921 mm		<b>SG 11432</b> Fascia eckig 73 mm		<b>SG 11531</b> Fascia rund 110 mm
	<b>SG 10699</b> Feder set F, 921 mm		<b>SG 11433</b> Box 73 mm		<b>SG 11532</b> Fascia eckig 110 mm
	<b>SG 10700</b> Feder set G, 921 mm		<b>SG 11434</b> Box Deckel 73 mm		<b>SG 11533</b> Box 110 mm
	<b>SG 10701</b> Doppelhalter Seitenführung		<b>SG 11437</b> Trägerabdeckung rund links 73 mm		<b>SG 11534</b> Box Deckel 110 mm
	<b>SG 10706</b> Draht Seitenführung ø 1.3 mm x 2.6 m		<b>SG 11438</b> Trägerabdeckung rund rechts 73 mm		<b>SG 11537</b> Trägerabdeckung rund links 110 mm
	<b>SG 10707</b> Endstop		<b>SG 11439</b> Trägerabdeckung eckig links 73 mm		<b>SG 11538</b> Trägerabdeckung rund rechts 110 mm
	<b>SG 10762</b> Enddeckel Seitenführung		<b>SG 11440</b> Trägerabdeckung eckig rechts 73 mm		<b>SG 11539</b> Trägerabdeckung eckig links 110 mm
	<b>SG 10770</b> Beschwerung		<b>SG 11442</b> Beschwerung		<b>SG 11540</b> Trägerabdeckung eckig rechts 110 mm
	<b>SG 10771</b> Enddeckel		<b>SG 11443</b> Enddeckel viereckig		<b>SG 11546</b> Träger links 110 mm



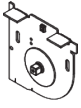

**SG 11547**

Träger rechts 110 mm

---



**SG 11548**

Träger links 110 mm

---

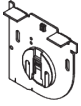

**SG 11549**

Träger rechts 110 mm

---





