

SG 2090

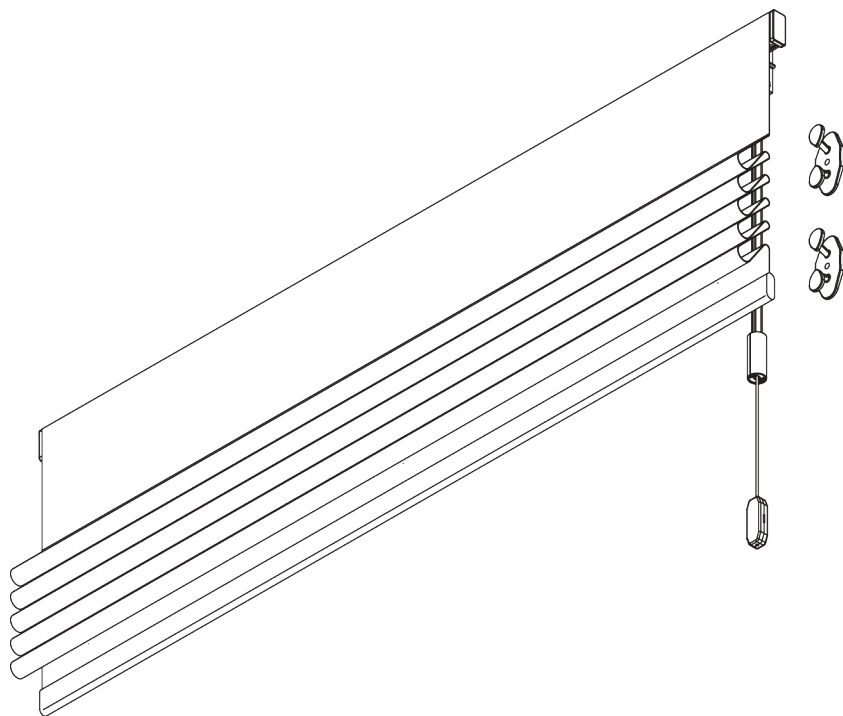

PRODUKTINFORMATIONEN

- **Bedienung:** Schnur
- **Grösse:** S
- **Montage:** Wand
- **Farben:** weiss RAL 9016
- **Stoffe:** siehe Silent Gliss Stoffkollektion

Merkmale:

- Einfache Montage am Fensterflügel

SYSTEMSPEZIFIKATIONEN

A. MASSE / GEWICHT



1 m

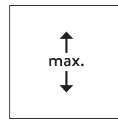

2 m



0.7 kg



2 m²

B. PROFIL

Profilinformationen

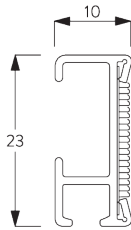

SG 2116
Velcroprofil

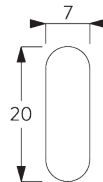

SG 2004
Beschwerung 20x7 mm

C. MASSAUFNAHME

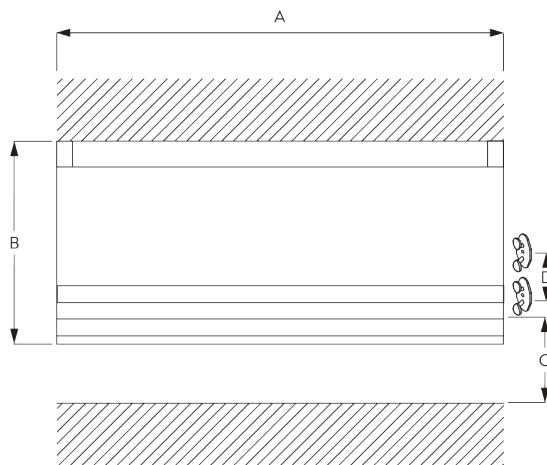

A: Systembreite

B: Systemhöhe

C: Schnuraufwickler SG 10742 min. 150 cm über Boden

D: 7 - 35 cm je nach Systemhöhe

MONTAGE

A. MONTAGE- INFORMATIONEN

Detaillierte Montageinformationen siehe
Silent Gliss Website

Montagepunkte

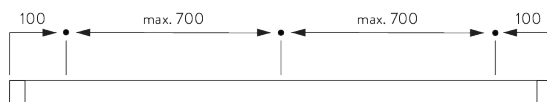

B. WANDMONTAGE

Clip SG 3666

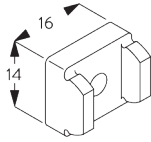
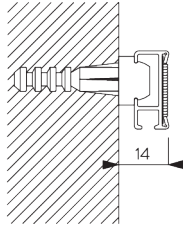

SG 3666

Träger

SYSTEMOPTIONEN

A. KONFEKTIONS- ARTEN

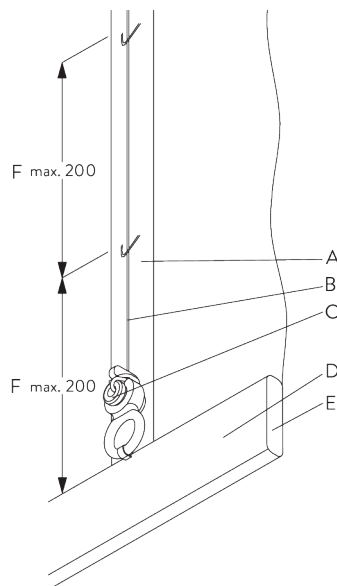

A: Laschenband SG 3074

B: Kordel SG 2216

C: Kindersicherheit Befestigungsset SG 3167

D: Hohlsaum

E: Beschwerung SG 2004

F: Kindersicherheit: Distanz max. 200 mm

KOMPONENTEN

A. STANDARD KOMPONENTEN

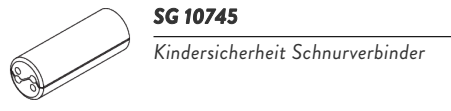
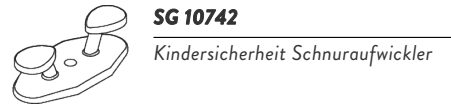
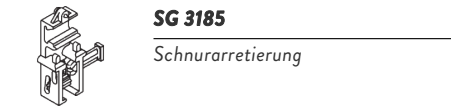
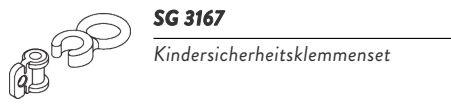
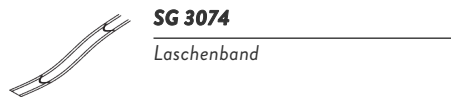
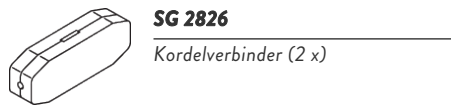
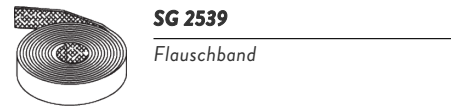
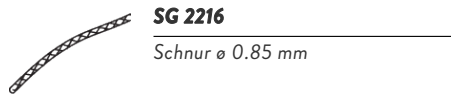
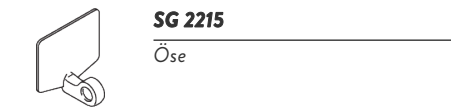
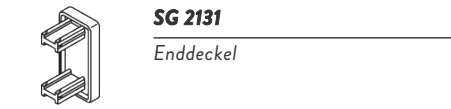
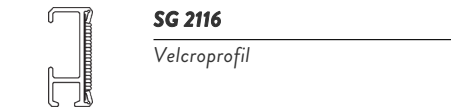

B. OPTIONALE KOMPONENTEN

